

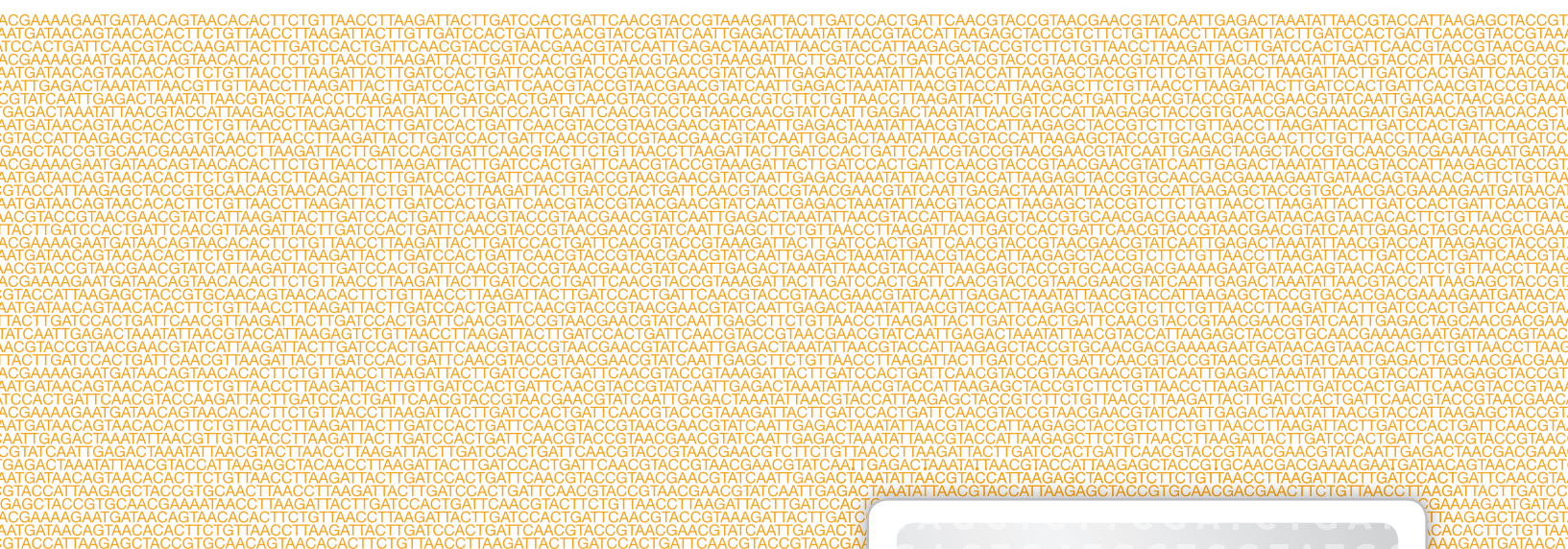

Infinium[®] HD Assay Methylation Protocol Guide



For Research Use Only. Not for use in diagnostic procedures.

ILLUMINA PROPRIETARY
Material # 20002138
Document # 15019519 v01
November 2015



This document and its contents are proprietary to Illumina, Inc. and its affiliates ("Illumina"), and are intended solely for the contractual use of its customer in connection with the use of the product (s) described herein and for no other purpose. This document and its contents shall not be used or distributed for any other purpose and/or otherwise communicated, disclosed, or reproduced in any way whatsoever without the prior written consent of Illumina. Illumina does not convey any license under its patent, trademark, copyright, or common-law rights nor similar rights of any third parties by this document.

The instructions in this document must be strictly and explicitly followed by qualified and properly trained personnel in order to ensure the proper and safe use of the product(s) described herein. All of the contents of this document must be fully read and understood prior to using such product(s).

FAILURE TO COMPLETELY READ AND EXPLICITLY FOLLOW ALL OF THE INSTRUCTIONS CONTAINED HEREIN MAY RESULT IN DAMAGE TO THE PRODUCT(S), INJURY TO PERSONS, INCLUDING TO USERS OR OTHERS, AND DAMAGE TO OTHER PROPERTY.

ILLUMINA DOES NOT ASSUME ANY LIABILITY ARISING OUT OF THE IMPROPER USE OF THE PRODUCT(S) DESCRIBED HEREIN (INCLUDING PARTS THEREOF OR SOFTWARE).

© 2015 Illumina, Inc. All rights reserved.

Illumina, 24sure, BaseSpace, BeadArray, BlueFish, BlueFuse, BlueGnome, cBot, CSPro, CytoChip, DesignStudio, Epicentre, ForenSeq, Genetic Energy, GenomeStudio, GoldenGate, HiScan, HiSeq, HiSeq X, Infinium, iScan, iSelect, MiSeq, MiSeqDx, MiSeq FGx, NeoPrep, NextBio, Nextera, NextSeq, Powered by Illumina, SureMDA, TruGenome, TruSeq, TruSight, Understand Your Genome, UYG, VeraCode, verifi, VeriSeq, the pumpkin orange color, and the streaming bases design are trademarks of Illumina, Inc. and/or its affiliate(s) in the U.S. and/or other countries. All other names, logos, and other trademarks are the property of their respective owners.

Revision History

Document	Date	Description of Change
Document # 15019519 v01	October 2015	<ul style="list-style-type: none">• Added instructions for processing an 8x1 BeadChip.• Corrected the temperature of the hybridization oven in the <i>Make the MSA4 Plate</i> and <i>Incubate DNA</i> sections to 37°C in both the Manual and Automated chapters.• Updated the total volume of PB1 required depending on the number of alignment fixtures being used.
Part # 15019519 C	May 2012	Indicated that up to 24 BeadChips can be washed with 550 ml of PB1.
Part # 15019519 B	April 2011	Incorporation of LIMS support.
Part # 15019519 A	December 2010	Initial release.

Table of Contents

Revision History	iii
Table of Contents	v
List of Tables	vii
Chapter 1 Overview	1
Introduction to Infinium HD Assay for Methylation	2
Audience and Purpose	3
Infinium HD Assay for Methylation	4
Illumina Infinium BeadChips	10
Illumina Lab Protocols	11
Tracking Tools	12
Tecan GenePaint	15
Imaging Systems	16
GenomeStudio Integrated Informatics Platform	17
Chapter 2 Manual Protocol	19
Introduction to Infinium HD Methylation Manual Protocol	20
Infinium HD Methylation Manual Workflow	21
Equipment, Materials, and Reagents	22
Quantify DNA [Optional] (Pre-Amp)	26
Make the BCD Plate (Pre-Amp)	33
Make MSA4 Plate (Pre-Amp)	39
Incubate MSA4 Plate	43
Fragment DNA (Post-Amp)	44
Precipitate DNA (Post-Amp)	46
Resuspend DNA (Post-Amp)	50
Hybridize to BeadChip (Post-Amp)	53
Wash BeadChips (Post-Amp)	72
Extend and Stain (XStain) BeadChip (Post-Amp)	84
Image BeadChip (Post-Amp)	103
Illumina GenomeStudio	104
Chapter 3 Automated Protocol	105
Introduction to Infinium HD Methylation Automated Protocol	106
Infinium HD Methylation Automated Workflow	107
Equipment, Materials, and Reagents	108

Quantify DNA [Optional] (Pre-Amp)	112
Make the BCD Plate (Pre-Amp)	122
Amplify DNA (Pre-Amp)	127
Incubate MSA4 Plate	136
Fragment DNA (Post-Amp)	138
Precipitate DNA (Post-Amp)	143
Resuspend DNA (Post-Amp)	151
Hybridize to BeadChips (Post-Amp)	156
Wash BeadChips (Post-Amp)	174
Extend and Stain (XStain) BeadChip (Post-AMP)	186
Image BeadChip (Post-Amp)	217
Illumina GenomeStudio	218
Appendix A System Controls	219
Introduction	220
Control Dashboard	221
Controls Table	222
Control Diagrams	224
Index	231
Technical Assistance	235

List of Tables

Table 1	Sample Sheet Guidelines	12
Table 2	AutoLoader Features	16
Table 3	User-Supplied Equipment Infinium HD Methylation Assay, Manual Protocol	22
Table 4	Illumina-Supplied Equipment Infinium HD Methylation Assay, Manual Protocol	22
Table 5	User-Supplied Materials Infinium HD Methylation Assay, Manual Protocol	22
Table 6	Illumina-Supplied Reagents, Infinium HD Methylation Assay, Manual Protocol	24
Table 7	Concentrations of Lambda DNA	28
Table 8	Volumes for PicoGreen Reagents	30
Table 9	Genomic DNA Input for Bisulfite Conversion	35
Table 10	User-Supplied Equipment Infinium HD Methylation Assay, Automated Protocol	108
Table 11	Illumina-Supplied Materials Infinium HD Methylation Assay, Automated	109
Table 12	User-Supplied Materials Infinium HD Methylation Assay, Automated Protocol	109
Table 13	Illumina-Supplied Reagents Infinium HD Methylation Assay, Automated Protocol	110
Table 14	Concentrations of Lambda DNA	114
Table 15	Volumes for PicoGreen Reagents	116
Table 16	Genomic DNA Input for Bisulfite Conversion	124
Table 17	List of Reactions	194
Table 18	Controls	222
Table 19	Illumina General Contact Information	235
Table 20	Illumina Customer Support Telephone Numbers	235

Overview

Introduction to Infinium HD Assay for Methylation	2
Audience and Purpose	3
Infinium HD Assay for Methylation	4
Illumina Infinium BeadChips	10
Illumina Lab Protocols	11
Tracking Tools	12
Tecan GenePaint	15
Imaging Systems	16
GenomeStudio Integrated Informatics Platform	17

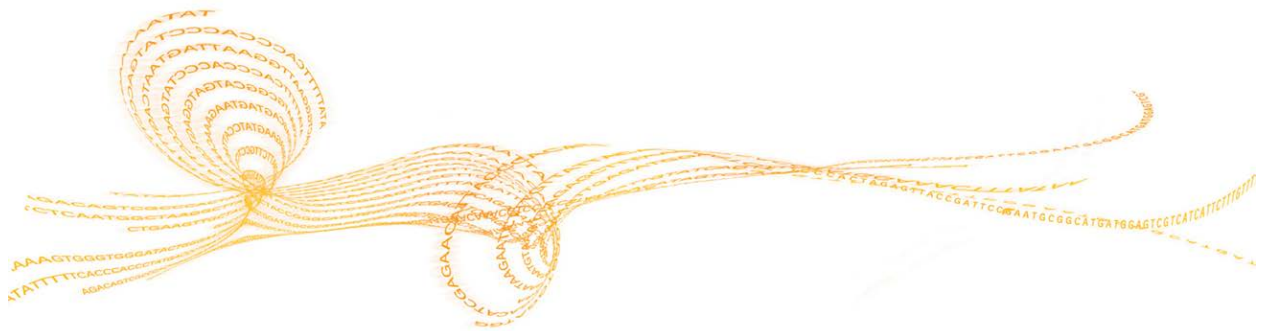

Introduction to Infinium HD Assay for Methylation

The Illumina® Infinium® HD Assay for methylation revolutionized DNA Methylation analysis by streamlining sample preparation and enabling high multiplexing. The Infinium HD Methylation Assay Protocol Guide scales methylation profiling to thousands of CpG loci per sample, and supports automation of large sample numbers.

The Infinium HD Methylation Assay Protocol Guide combines bisulfite conversion of genomic DNA and whole-genome amplification (WGA) with direct, array-based capture and scoring of the CpG loci. Signal intensity is measured with the Illumina iScan or HiScan system to generate beta values, a measure of the degree of methylation at a locus. Beta values can be interrogated and compared across samples for powerful large-scale studies. One or 2 probes are used to interrogate a CpG locus, depending on the probe design for a particular CpG site. (The Infinium I design has 2 probes per site and Infinium II has one probe per site.) The 3' end of the probes is positioned directly across from the CpG site (for Infinium I) or immediately adjacent to the site (for Infinium II).

Allele-specific single base Extension of the probes incorporates a biotin nucleotide or a dinitrophenyl labeled nucleotide. (C and G nucleotides are biotin labeled; A and T nucleotides are dinitrophenyl labeled.) Signal amplification of the incorporated label further improves the overall signal-to-noise ratio of the assay.

The Infinium HD Methylation Assay Protocol Guide offers:

- ▶ High multiplexing
- ▶ Single tube amplification—Single chip—No PCR
- ▶ Minimal risk of carryover contamination
- ▶ Low DNA input into bisulfite conversion:
 - as low as 250 ng and up to 1 µg for the manual process on fresh DNA (higher input results in higher reproducibility between samples)
 - 250 ng for FFPE DNA
 - 1000 ng for automated process
- ▶ Walk-away automation using Tecan Genesis or Freedom EVO Robots and Tecan GenePaint system
- ▶ Compatibility with both Illumina iScan® and HiScan® Systems
- ▶ Multiple-Sample (12 or 8) BeadChip format

Audience and Purpose

This guide is for laboratory technicians running the Infinium HD Assay for Methylation. The guide documents the laboratory protocols for both 8x1 and 12x1 sample arrays associated with the assay. Follow all the protocols in the order shown.

Chapter 2 Manual Protocol explains how to run the assay manually in the lab.

Chapter 3 Automated Protocol explains how to automate the protocol with the aid of the Tecan 8-tip robot.

Important Note

Before following any of the procedures in this guide, read the *Infinium Lab Setup and Procedures Guide*, which explains how to equip and run an Infinium HD Assay for Methylation laboratory. The guide includes important information on the following topics:

- ▶ Prevention of amplification product contamination
- ▶ Safety precautions
- ▶ Equipment, materials, and reagents to purchase in advance
- ▶ Standard lab procedures
- ▶ Robot use for automation
- ▶ Preparation for BeadChip imaging
- ▶ System maintenance
- ▶ GenomeStudio® controls analysis
- ▶ Troubleshooting

The instructions apply equally to all Infinium BeadChips provided by Illumina. All Infinium HD Methylation documentation assumes that you have already set up the laboratory space and are familiar with the standard procedures and safety precautions.

Before run set up, download the DMAP files for the array, and prepare a sample sheet. The DMAP files can be downloaded from the support page.

Infinium HD Assay for Methylation

This section describes and illustrates the assay protocol. The assay requires only 500 ng of gDNA for the manual assay or 1000 ng of gDNA for the automated assay input into bisulfite conversion.

Bisulfite Conversion (Pre-AMP)

DNA is treated with sodium bisulfite using an Illumina specified bisulfite conversion kit. After the treatment, unmethylated cytosines convert to uracil, though methylated cytosines remain unchanged.

Figure 1 Bisulfite Conversion

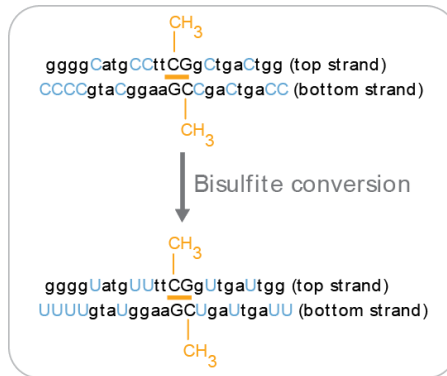

Amplify BCD (Pre-AMP)

The BCD samples are denatured and neutralized to prepare them for amplification.

Figure 2 Denaturing and Neutralizing BCD

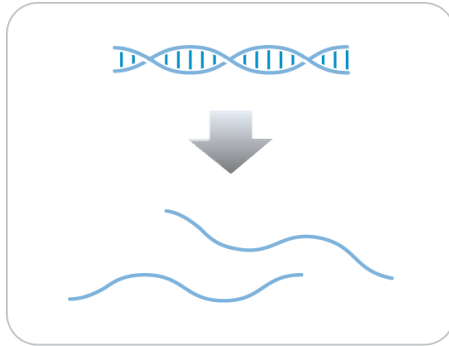

Incubate DNA (Post-Amp)

The denatured DNA is isothermally amplified in an overnight step. The whole-genome amplification uniformly increases the amount of the DNA sample by several thousand-folds without significant amplification bias.

Figure 3 Incubating DNA to Amplify

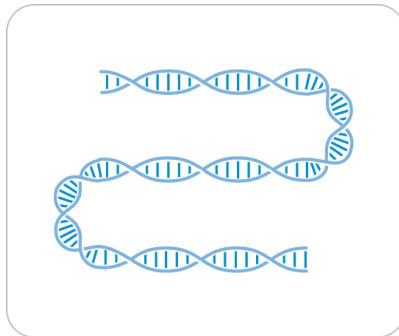

Fragment DNA (Post-Amp)

A controlled enzymatic process fragments the amplified product. The process uses endpoint fragmentation to prevent overfragmentation.

Figure 4 Fragmenting DNA



Precipitate DNA (Post-Amp)

After an isopropanol precipitation, centrifugation at 4°C collects the fragmented DNA.

Figure 5 Precipitating DNA

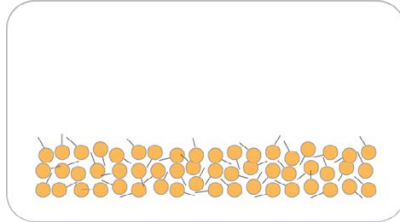

Resuspend DNA (Post-Amp)

The precipitated DNA is resuspended in Hybridization Buffer.

Figure 6 Resuspending DNA

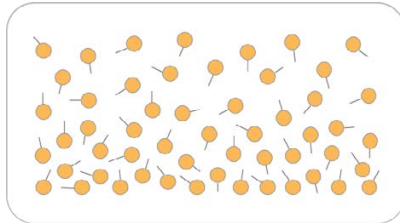

Hybridize to BeadChip (Post-Amp)

Dispense the fragmented, resuspended DNA samples onto BeadChips. Incubate the BeadChips in the Illumina Hybridization Oven to hybridize the samples onto the BeadChips.

Twelve samples are applied to each BeadChip, which keeps them separate with an IntelliHyb seal. The prepared BeadChip is incubated overnight in the Illumina Hybridization Oven. The amplified and fragmented DNA samples anneal to locus-specific 50mers (covalently linked to 1 of over 500,000 bead types) during hybridization. Two bead types correspond to each CpG locus for Infinium I assays: one bead type corresponds to methylated (C), another bead type to unmethylated (T) state of the CpG site. One bead type corresponds to each CpG locus for Infinium II assays.

Figure 7 Hybridize to BeadChip

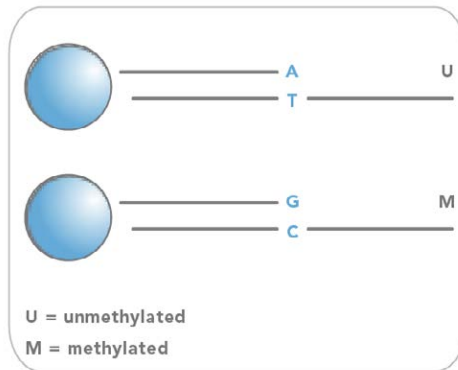

Wash BeadChip (Post-Amp)

Unhybridized and nonspecifically hybridized DNA is washed away and the BeadChip is prepared for staining and extension.

Figure 8 Washing BeadChip

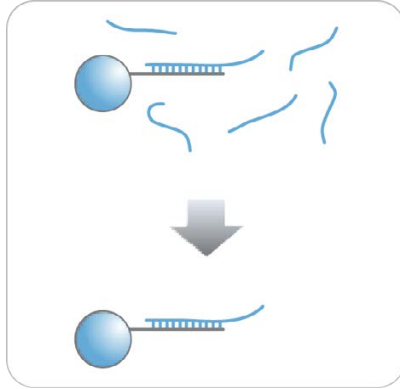

Extend and Stain (XStain) BeadChip (Post-Amp)

The chip undergoes extension and staining in capillary flow-through chambers. Single-base extension of the oligos on the BeadChip, using the captured DNA as a template, incorporates detectable labels on the BeadChip and determines the methylation level of the query CpG sites.

Figure 9 Extending and Staining BeadChip

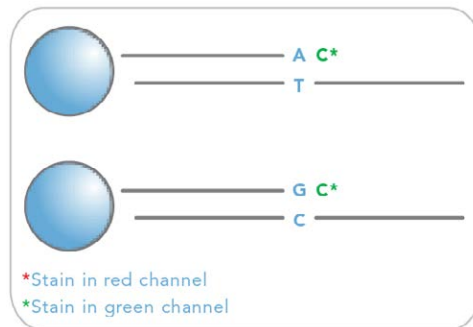
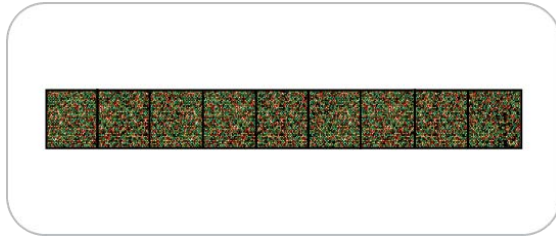

Image BeadChip (Post-Amp)

The Illumina HiScan or iScan System scans the BeadChip, using a laser to excite the fluorophore of the single-base extension product on the beads. The scanner records high-resolution images of the light emitted from the fluorophores.

Figure 10 Imaging BeadChip



Illumina Infinium BeadChips

Illumina Infinium BeadChips are sophisticated silicon-based array devices. An IntelliHyb seal separates the sample sections of the slide so that you can run multiple samples simultaneously.

Each individual sample section holds oligonucleotide probe sequences that are attached to beads assembled into the microwells of the BeadChip substrate. Because the microwells outnumber the distinct bead types, multiple copies of each bead type are present in the array. This built-in redundancy improves robustness and measurement precision. The BeadChip manufacturing process includes hybridization-based quality controls of each array feature, allowing consistent production of high-quality, reproducible arrays.

Illumina Lab Protocols

Illumina lab protocols are designed to promote efficiency and minimize the risk of contamination. The *Infinium Lab Setup and Procedures Guide* documents standard operating procedures and tools for an Infinium Assay lab and explains how to set up and maintain separate pre- and post-amplification areas. Familiarize yourself with this guide before performing any Infinium assays.

Chapter 2 Manual Protocol and Chapter 3 Automated Protocol show how to perform the assay protocol with clearly divided pre- and post-amplification processes using a manual and automated process respectively.

Tracking Tools

Illumina provides the following tools for sample tracking and guidance in the lab:

- ▶ **Experienced User Cards** to guide you through the protocols. There are separate sets of cards for the manual and automated processes.
- ▶ **Lab Tracking Form** to map DNA samples to BeadChips and record the barcode of each reagent and plate used in the protocol.
- ▶ **Sample sheet template** to record information about your samples for later use in data analysis.

All these documents are available for printing and reference at www.illumina.com/documentation.

Sample Sheet

To track your samples and assay, Illumina recommends that you create a sample sheet. The sample sheet is later used by the GenomeStudio application for data analysis. For instructions on data analysis, see the *GenomeStudio Methylation Module User Guide*.

Create your Sample Sheet according to the guidelines provided in this table.

Table 1 Sample Sheet Guidelines

	Description	Optional (O) or Required (R)
Sample_Name	Example: S12345 If not user-specified, the GenomeStudio application assigns a default sample name, concatenating the sample plate and sample well names.	R
Sample_Plate	Example: GS0005623-BCD User-specified name for the plate containing bisulfite-converted DNA samples.	O
Sample_Well	Example: A01 The well containing the specific sample in the MSA4 plate.	O

	Description	Optional (O) or Required (R)
Sample_Group	Example: Group 1 User-specified name of the sample group. If the Sample_Group is missing, GenomeStudio creates one group and assigns it a default name.	R
Pool_ID	N/A	N/A
Sentrix_ID	Example: 1529221001 BeadChip ID.	R
Sentrix_Position	R01C01, R01C02, and so on- position of the sample on the BeadChip	R
Notes	Your sample sheet header can contain whatever information you choose. Your sample sheet can contain any number of columns you choose. Your sample sheet must be in a comma-delimited (.csv) file format. Commas in the sample sheet are not allowed. Save the sample sheet under any name you wish; for example, the user-defined experiment name.	

The following figure provides an example of the sample sheet format. Product documentation includes an electronic, read-only sample sheet template file (**Sample Sheet Template.csv**) that you can copy and use.

Figure 11 Sample Sheet Example

The screenshot shows a Microsoft Excel spreadsheet titled "HumanMethylation450_Sample_sheet_Example.csv [Read-Only] - Microsof...". The spreadsheet is organized into several sections:

- Row 1:** A1 cell contains "[Header]".
- Row 2:** "Investigat Scientist"
- Row 3:** "Project N: DNA Methylation"
- Row 4:** "Experime Test"
- Row 5:** "Date" in A5, "8-Dec-10" in B5.
- Row 6:** Empty.
- Row 7:** A7 cell contains "[Data]".
- Row 8:** Headers for data: "Sample_N", "Sample_V", "Sample_P", "Sample_G", "Pool_ID", "Sentrix_IC", "Sentrix_Position".
- Rows 9-30:** Data rows for samples 1 through 22. Each row contains sample names, group identifiers, and numerical values in scientific notation.

Sample_N	Sample_V	Sample_P	Sample_G	Pool_ID	Sentrix_IC	Sentrix_Position
Sample1			Group1		5.58E+09	R01C01
Sample2			Group1		5.58E+09	R01C02
Sample3			Group2		5.58E+09	R02C01
Sample4			Group2		5.58E+09	R02C02
Sample5			Group3		5.58E+09	R03C01
Sample6			Group3		5.58E+09	R03C02
Sample7			Group1		5.58E+09	R04C01
Sample8			Group1		5.58E+09	R04C02
Sample9			Group2		5.58E+09	R05C01
Sample10			Group2		5.58E+09	R05C02
Sample11			Group3		5.58E+09	R06C01
Sample12			Group3		5.58E+09	R06C02
Sample13			Group1		5.58E+09	R01C01
Sample14			Group1		5.58E+09	R01C02
Sample15			Group2		5.58E+09	R02C01
Sample16			Group2		5.58E+09	R02C02
Sample17			Group3		5.58E+09	R03C01
Sample18			Group3		5.58E+09	R03C02
Sample19			Group1		5.58E+09	R04C01
Sample20			Group1		5.58E+09	R04C02
Sample21			Group2		5.58E+09	R05C01
Sample22			Group2		5.58E+09	R05C02

Tecan GenePaint

The Infinium HD Assay for Methylation uses the GenePaint automated slide processor on the Tecan to process BeadChips. The GenePaint system employs a capillary gap flow-through chamber to enable reagent entrapment and exchange over the active surface of the BeadChip. Washing, blocking, extension, and signal amplification happen simply by adding reagents to the flow cell. Addition of a new reagent displaces the entrapped reagent from the flow cell. For maximum flexibility, these additions can be performed either manually or via the Tecan Genesis or Tecan Freedom EVO robots. The optional automated robotic processing and single-use reagent tube barcoding assure maximum consistency from slide to slide.



CAUTION

When using the Tecan robot, do not run any other programs or applications. Your computer and the robot can lock up and stop a run.

Imaging Systems

BeadChips are imaged using either the Illumina iScan System or HiScan System. Both of these systems are two-channel high-resolution laser imagers that scan BeadChips at 2 wavelengths simultaneously and create an image file for each channel (ie, 2 per array).

The iScan Control Software determines intensity values for each bead type and creates data files for each channel. GenomeStudio uses this data file with the individual bead pool map (*.bpm) to analyze the data from the assay.

Loading and unloading the iScan System or HiScan System can be automated with the optional AutoLoader2. AutoLoaders support unattended processing by placing BeadChips carriers in the imaging tray, so that it can scan the BeadChips. AutoLoader features include:

Table 2 AutoLoader Features

Feature	AutoLoader2	AutoLoader 2x
Integrated with iScan Control Software	•	•
Integrated with Illumina LIMS	•	•
Email alert system	•	•
Single-reader or dual-reader configuration	•	•
Number of BeadChips supported per carrier	4	4
Number of carriers processed at a time	48	48

GenomeStudio Integrated Informatics Platform

Illumina GenomeStudio, an integrated data analysis software platform, provides a common environment for analyzing data obtained from microarray and sequencing technologies. Within this common environment, or framework, the Illumina GenomeStudio software modules allow you to perform application-specific analyses. The Illumina GenomeStudio Methylation Module, included with your Illumina Infinium Methylation Assay system, is an application for extracting genome-wide DNA methylation data from data files collected from systems such as the IlluminaHiScan Reader. Experiment performance is based on built-in controls that accompany each experiment.

Data analysis features of the Illumina GenomeStudio Methylation Module include:

- ▶ Choice of assay analysis within a single application
- ▶ Data tables for information management and manipulation
- ▶ Plotting and graphing tools
- ▶ Whole-genome display of sample data in the IGV (Illumina Genome Viewer)
- ▶ Data visualization of one or more samples in the ICB (Illumina Chromosome Browser)
- ▶ Data normalization
- ▶ Custom report file formats
- ▶ Differential methylation analysis
- ▶ Assay-specific controls dashboards

For feature descriptions and instructions on using the Illumina GenomeStudio platform to visualize and analyze genome-wide DNA methylation data, see the *GenomeStudio Framework User Guide* and the *GenomeStudio Methylation Module User Guide*.

For technical assistance, contact Illumina Technical Support.

Manual Protocol

Introduction to Infinium HD Methylation Manual Protocol	20
Infinium HD Methylation Manual Workflow	21
Equipment, Materials, and Reagents	22
Quantify DNA [Optional] (Pre-Amp)	26
Make the BCD Plate (Pre-Amp)	33
Make MSA4 Plate (Pre-Amp)	39
Incubate MSA4 Plate	43
Fragment DNA (Post-Amp)	44
Precipitate DNA (Post-Amp)	46
Resuspend DNA (Post-Amp)	50
Hybridize to BeadChip (Post-Amp)	53
Wash BeadChips (Post-Amp)	72
Extend and Stain (XStain) BeadChip (Post-Amp)	84
Image BeadChip (Post-Amp)	103
Illumina GenomeStudio	104



Introduction to Infinium HD Methylation Manual Protocol

This chapter describes pre- and post-amplification manual laboratory protocols for the Infinium HD Assay for Methylation. Follow the protocols in the order shown.

Infinium HD Methylation Manual Workflow

The following figure graphically represents the Infinium HD Methylation Assay Protocol Guide manual workflow for the Infinium Methylation BeadChips. These protocols describe the procedure for preparing 96 DNA samples.

Figure 12 Infinium HD Methylation Assay Protocol Guide Manual Workflow

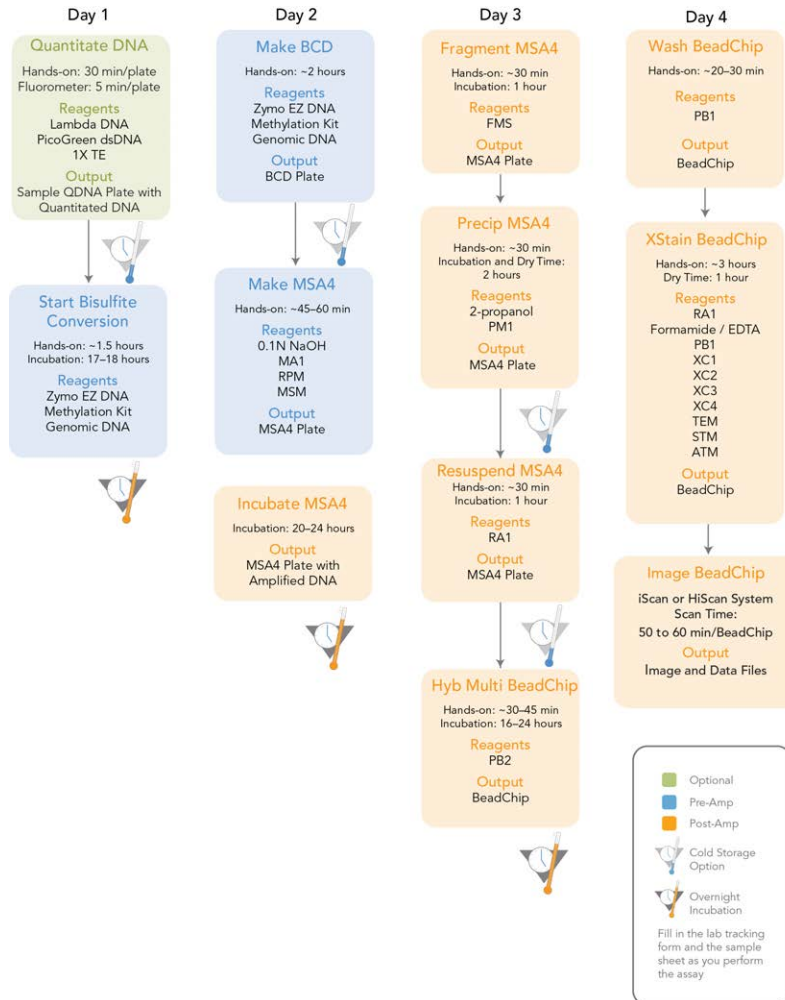

Equipment, Materials, and Reagents

These materials are specific to the manual Infinium HD Assay for Methylation. For a list of other equipment, materials, and reagents needed in a lab performing Illumina Infinium assays, see the *Infinium Lab Setup and Procedures Guide*.

User-Supplied Equipment

Table 3 User-Supplied Equipment Infinium HD Methylation Assay, Manual Protocol

Item	Catalog #
Autodesiccator cabinet (Optional— Allows scanning of BeadChips up to 3 days after processing)	VWR, catalog # 74950-342

Illumina-Supplied Equipment

Table 4 Illumina-Supplied Equipment Infinium HD Methylation Assay, Manual Protocol

Item	Catalog #
Multi-Sample BeadChip Alignment Fixture	218528

User-Supplied Materials

Table 5 User-Supplied Materials Infinium HD Methylation Assay, Manual Protocol

Item	Catalog #
Robots	Tecan
Tube vortexer	General lab supplier
Tube rack	VWR
Combination optical tachometer/stroboscope	Cole-Parmer, catalog # A-87700-06

Item	Catalog #
Microplate centrifuge with g-force range 8–3000 × g, for dedicated pre- and post-amp use	General lab supplier
Adapter for centrifuge plates and tubes	General lab supplier
Pipettes (2 separate sets)	2 each of P-20, P-200, and P-1000
8-channel precision pipette (2 separate sets)	50 µl to 300 µl
Stop watch/timer	General lab supplier
Forceps	VWR, catalog # 25601-008
Powder-free gloves (2 separate stocks)	General lab supplier
Lab coats (separate pre-PCR and post-PCR)	General lab supplier
Safety glasses (2 separate stocks)	General lab supplier
15 ml conical tubes	General lab supplier
96-well 0.2 ml skirted microplates	MJ Research, catalog # MSP-9601
0.8 ml storage plate (midi plate), conical well-bottom	Abgene, catalog # AB-0765
Heat sealing foil sheets, Thermo-Seal	Abgene, catalog # AB-0559
96-well cap mats (pierceable, nonautoclavable)	Abgene, catalog # AB-0566
Absorbent pads	General lab supplier
Kimwipes	General lab supplier
Mild detergent, such as Alconox Powder	VWR, catalog ## 21835-032
Detergent	General lab supplier
Aerosol filter pipette tips (2 separate stocks)	20 µl, 200 µl, 1000 µl
Disposable pipetting troughs	VWR, catalog # 21007-970

Item	Catalog #
Reservoir, full, 150 ml	Beckman Coulter, catalog # 372784
Reservoir, half, 75 ml	Beckman Coulter, catalog # 372786
Reservoir, quarter, 40 ml	Beckman Coulter, catalog #372790
Reservoir frame	Beckman Coulter, catalog # 372795

Illumina-Supplied Materials

- ▶ WG#-MSA4 barcode labels
- ▶ WG#-BCD barcode labels

Illumina-Supplied Reagents

Table 6 Illumina-Supplied Reagents, Infinium HD Methylation Assay, Manual Protocol

Item	Part #
ATM —Anti-Stain Two-Color Master Mix	11208317
FMS —Fragmentation solution	11203428
MA1 —Multi-Sample Amplification 1 Mix	11202880
RPM —Random Primer Mix	15010230
MSM —Multi-Sample Amplification Master Mix	11203410
PB1 —Reagent used to prepare BeadChips for hybridization	11291245
PB2 —Humidifying buffer used during hybridization	11191130
PM1 —Precipitation solution	11292436

Item	Part #
RA1 —Resuspension, hybridization, and wash solution	11292441
STM —Superior Two-Color Master Mix	11288046
TEM —Two-Color Extension Master Mix	11208309
XC1 —XStain BeadChip solution 1	11208288
XC2 —XStain BeadChip solution 2	11208296
XC3 —XStain BeadChip solution 3	11208392
XC4 —XStain BeadChip solution 4	11208430

Quantify DNA [Optional] (Pre-Amp)

Illumina recommends the Molecular Probes PicoGreen assay to quantify dsDNA samples. The PicoGreen assay can quantify small DNA volumes and measures DNA directly. Other techniques might pick up contamination such as RNA and proteins. Illumina recommends using a spectrofluorometer because fluorometry provides DNA-specific quantification. Spectrophotometry might also measure RNA and yield values that are too high.

Estimated Time

Hands-on time: ~20 minutes per plate plus 10 minutes to prepare the PicoGreen
Spectrofluorometer read time: ~5 minutes per plate

Consumables

Item	Quantity	Storage	Supplied By
PicoGreen dsDNA quantification reagent	See Instructions	2° to 8°C	User
1X TE	See Instructions	Room temperature	User
Lambda DNA	See Instructions	2° to 8°C	User
96-well 0.65 ml microplate	1 per 96 samples		User
FLUOTRAC 200 96-well flat-bottom plate	1 per Std DNA plate 1 per Sample DNA plate		User

Preparation

- ▶ Thaw PicoGreen to room temperature for 60 minutes in a light-impermeable container.
- ▶ Hand-label the microplate “Standard DNA.”
- ▶ Hand-label 1 of the FLUOTRAC plates “Standard QDNA.”
- ▶ Hand-label the other FLUOTRAC plate “Sample QDNA.” This plate contains the quantified DNA.

- ▶ In the sample sheet, enter the Sample_Name (optional) and Sample_Plate for each Sample_Well.

Make a Standard DNA Plate

In this process, you create a Standard DNA plate with serial dilutions of stock Lambda DNA in the wells of column 1.

- 1 Add stock Lambda DNA to well A1 in the plate labeled “Standard DNA” and dilute it to 75 ng/μl in a final volume of 233.3 μl. Pipette up and down several times.
 - a Use the following formula to calculate the amount of stock Lambda DNA to add to A1:

$$\frac{(233.3 \mu\text{l}) \times (75 \text{ ng}/\mu\text{l})}{(\text{stock Lambda DNA concentration})} = \mu\text{l of stock Lambda DNA to add to A1}$$
 - b Dilute the stock DNA in well A1 using the following formula:

$$\mu\text{l of 1X TE to add to A1} = 233.3 \mu\text{l} - \mu\text{l of stock Lambda DNA in well A1}$$
- 2 Add 66.7 μl 1X TE to well B1.
- 3 Add 100 μl 1X TE to wells C, D, E, F, G, and H of column 1.

Figure 13 Dilution of Stock Lambda DNA Standard

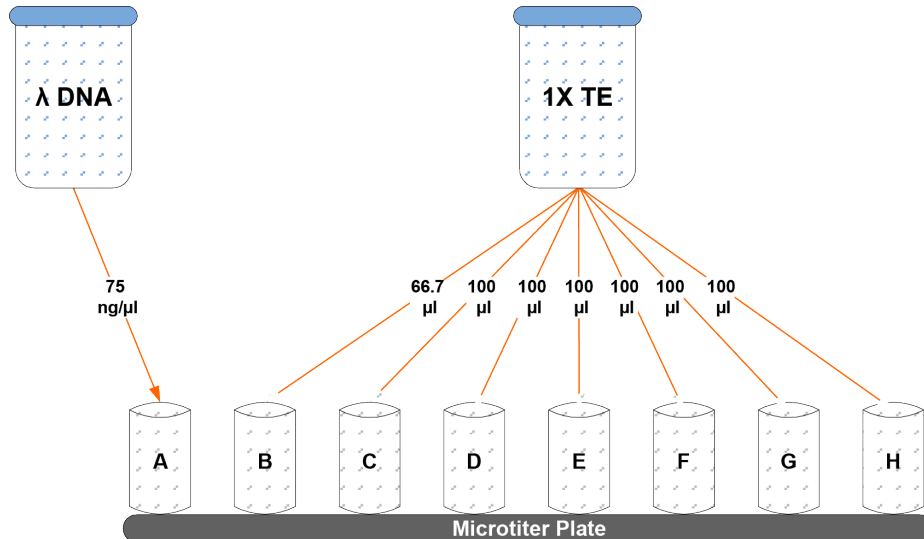

- 4 Transfer 133.3 μl of Lambda DNA from well A1 into well B1. Pipette up and down several times.
- 5 Change tips. Transfer 100 μl from well B1 into well C1. Pipette up and down several times.
- 6 Repeat for wells D1, E1, F1, and G1, changing tips each time. **Do not transfer from well G1 to H1.** Well H1 serves as the blank 0 ng/ μl Lambda DNA.

Table 7 Concentrations of Lambda DNA

Row-Column	Concentration (ng/ μl)	Final Volume in Well (μl)
A1	75	100
B1	50	100
C1	25	100
D1	12.5	100
E1	6.25	100
F1	3.125	100
G1	1.5262	200
H1	0	100

Figure 14 Serial Dilutions of Lambda DNA

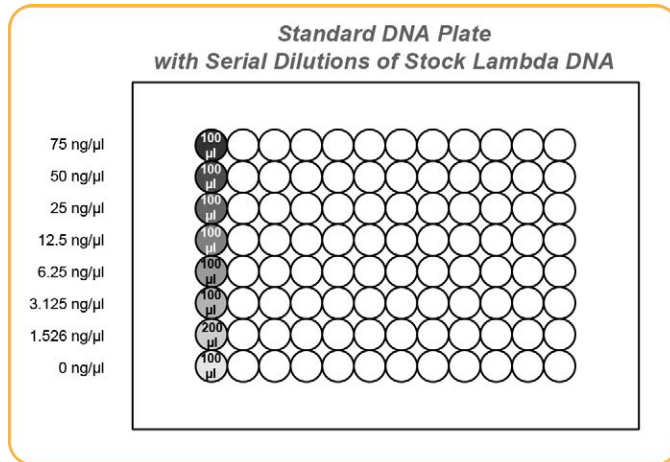

- Cover the Standard DNA plate with cap mat.

Dilute PicoGreen

The diluted PicoGreen is added to both the Standard QDNA and Sample QDNA plates to make the DNA fluoresce when read with the spectrofluorometer.



CAUTION

PicoGreen reagent degrades quickly in the presence of light. Also, do not use glass containers for PicoGreen reagent, because it adheres to glass, lowering its effective concentration in solution and effecting the upper response range accuracy.

- Prepare a 1:200 dilution of PicoGreen into 1X TE using a sealed 100 ml or 250 ml Nalgene bottle wrapped in aluminum foil.
Refer to the following table to identify the volumes to produce diluted reagent for multiple 96-well QDNA plates. For fewer than 96 DNA samples, scale down the volumes.

Table 8 Volumes for PicoGreen Reagents

# QDNA Plates	PicoGreen Volume (μl)	1X TE Volume (ml)
1	115	23
2	215	43
3	315	63

- 2 Cap the foil-wrapped bottle and vortex to mix.

Create QDNA Standard Plate with Diluted PicoGreen

In this process, you transfer the serial dilutions from the Standard DNA plate into the Standard QDNA FLUOTRAC plate and add diluted PicoGreen.

- 1 Pour the PicoGreen/1X TE dilution into a clean reagent reservoir.
- 2 Using a multichannel pipette, transfer 195 μl PicoGreen/1X TE dilution into each well of columns 1 and 2 of the FLUOTRAC plate labeled “Standard QDNA”.
- 3 Add 2 μl of each stock Lambda DNA dilution from the Standard DNA plate to columns 1 and 2 of the Standard QDNA FLUOTRAC plate.

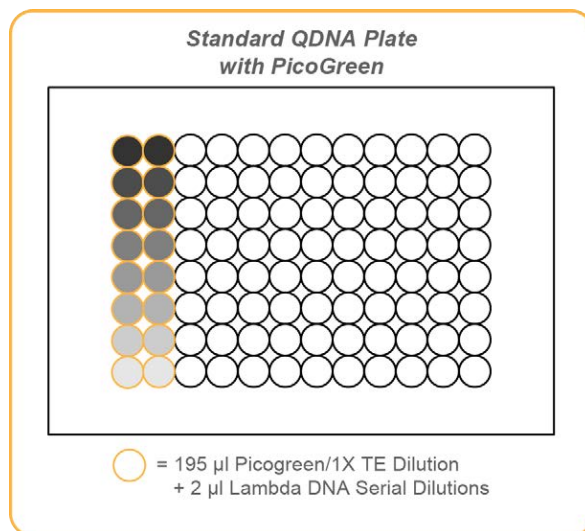
Figure 15 Standard QDNA Plate with PicoGreen

- 4 Immediately cover the plate with an adhesive aluminum seal.

Prepare QDNA Sample Plate with PicoGreen and DNA

In this process, create a Sample QDNA plate that contains DNA sample and PicoGreen.

- 1 Using a multichannel pipette, transfer 195 μl PicoGreen/1X TE dilution into each well of columns 1 and 2 of the FLUOTRAC plate labeled "Sample QDNA".
- 2 Add 2 μl of DNA sample to all 96 wells of the Sample QDNA plate. Only the first 2 columns contain PicoGreen/1X TE dilution.

Figure 16 Sample QDNA Plate with PicoGreen

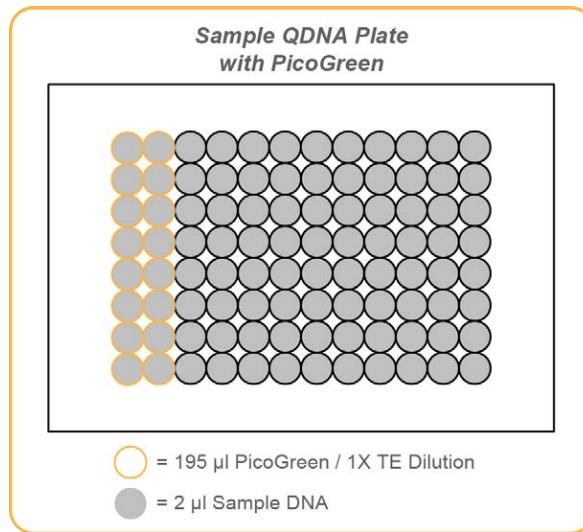

- 3 Immediately cover the plate with an adhesive aluminum seal.

Read QDNA Plate

In this process, you use the Gemini XS or XPS spectrofluorometer to read the Standard QDNA and Sample QDNA plates. The spectrofluorometer creates a standard curve from the known concentrations in the Standard QDNA plate, which you use to determine the concentration of DNA in the Sample QDNA plates. For the best performance, Illumina recommends a minimum concentration of 50 $\text{ng}/\mu\text{l}$.



NOTE

The SoftMax Pro screens and menu options might vary from the options described here, depending on the software version that you are running.

- 1 Turn on the spectrofluorometer. At the PC, open the SoftMax Pro program.
- 2 Load the Illumina QDNA.ppr file from the installation CD that came with your system.
- 3 Select **Protocols | GTS_QDNA**.
- 4 Place the Standard QDNA FLUOTRAC Plate into the spectrofluorometer loading rack with well A1 in the upper left corner.
- 5 Click the blue arrow next to **Illumina QDNA | SQDNA_STD**.
- 6 Click **Read** in the SoftMax Pro interface to begin reading the Standard QDNA Plate.
- 7 When the software finishes reading the data, remove the plate from the drawer.
- 8 Click the blue arrow next to **Standard Curve** to view the standard curve graph.
- 9 If the standard curve is acceptable, continue with the sample plate. Otherwise, click **Standard Curve** again.
- 10 Place the first Sample QDNA plate in the spectrofluorometer with well A1 in the upper left corner.
- 11 Click the blue arrow next to **SQDNA** and click **Read**.
- 12 When the software finishes reading the plate, remove the plate from the drawer.
- 13 Repeat steps 10 through 12 to quantify all Sample QDNA plates.
- 14 When all plates have been read, click **File | Save** to save the output data file (*.pda).
- 15 When you have saved the *.pda file, click **File | Import/Export | Export** and export the file as a *.txt file. You can open the *.txt file in Microsoft Excel for data analysis.
- 16 Do either of the following:
 - Proceed to Make the BCD Plate (Pre-AMP).
 - Store the quantitated DNA at 2° to 8°C for up to one month.

Make the BCD Plate (Pre-Amp)

This process uses the Zymo EZ DNA Methylation Kit to convert unmethylated cytosines (C) in genomic DNA to uracil (U), though leaving methylated cytosines (C) unchanged for methylation analysis.

Figure 17 Bisulfite Conversion

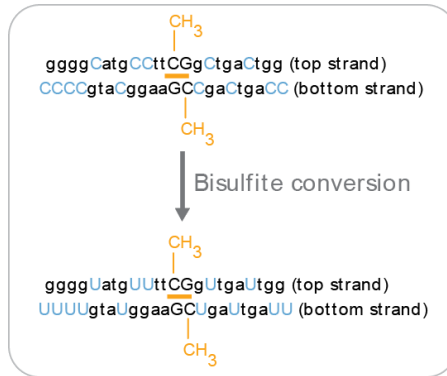

Methylation detection in bisulfite-converted DNA (BCD) is based on the different sensitivity of cytosine and 5-methylcytosine to deamination by bisulfite. Under acidic conditions, cytosine undergoes conversion to uracil, though methylated cytosine remains unreactive. An effective bisulfite conversion protocol is a prerequisite for a successful Infinium HD Assay for Methylation. Incomplete conversion of cytosine to uracil can result in false-positive methylation signals, and can reduce the overall quality of the assay data.



NOTE

Always perform bisulfite conversion of DNA in the pre-amp area.

Figure 18 Bisulfite Conversion Workflow

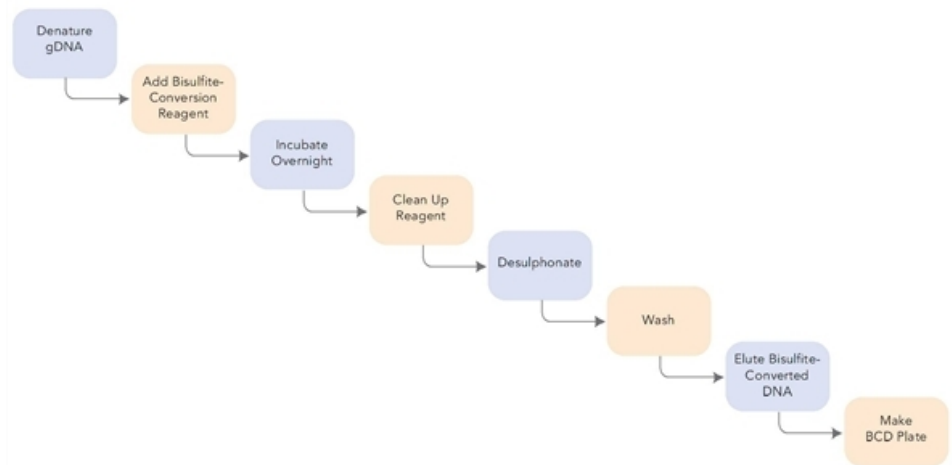

Bisulfite convert the genomic DNA samples using the Zymo EZ DNA Methylation Kit. Transfer the bisulfite-converted samples to the BCD plate.

Estimated Time

Hands-on time:

- ~1.5 hours on Day 1
- ~2 hours on Day 2

Incubation time: 16–17 hours on Day 1 (Overnight)

Consumables

Item	Quantity	Storage	Supplied By
Zymo EZ DNA Methylation kit (includes bisulfite conversion reagent, dilution buffer, desulphonation buffer, elution buffer)	1 kit per 50 samples 1 kit per 200 samples or 1 kit per 2 plates	Room temperature	User

Item	Quantity	Storage	Supplied By
96-well 0.2 ml skirted microplate	1–3 plates		User
Genomic DNA (for HD Methylation)	≥ 250 ng for each bisulfite conversion reaction ≥1000 ng for each bisulfite conversion reaction		User
FFPE DNA (for HD FFPE Methylation)	≥250 ng for each bisulfite conversion reaction for manual or automated process		

Illumina recommends using the Zymo Research EZ DNA methylation kit for bisulfite conversion of genomic DNA. Follow Illumina recommended incubation conditions during bisulfite conversion to maximize DNA conversion rate.

For all other steps, follow the instructions from the manufacturer for use, because the protocols vary significantly for different kits.



CAUTION

Bisulfite conversion kits that are not specified in this guide are not supported for use with the Infinium HD Methylation Assay Protocol Guide.



NOTE

Illumina supports down to 250 ng fresh DNA for this reaction. When possible, using more DNA, such as 500 ng or 1000 ng, results in higher reproducibility.

Preparation

Use this table to determine the correct amount of genomic DNA for each bisulfite conversion process.

Table 9 Genomic DNA Input for Bisulfite Conversion

	Amount of gDNA	Elution Buffer	Number of Activation Reactions Supported
Manual process	> 500 ng	12 µl	Enough for 2 replicates
Automated process	1000 ng	22 µl	Enough for 2 replicates

- ▶ Prepare the conversion reagent according to the instructions from the manufacturer. For best results, use it immediately.

**CAUTION**

The conversion reagent is photosensitive, so minimize its exposure to light.

- ▶ Prepare the wash buffer according to the manufacturer instructions.
- ▶ Apply a BCD barcode label to each new 96-well 0.2 ml skirted microplate.
- ▶ On the Lab Tracking Form, record the following:
 - Date and time
 - Operator

**NOTE**

To record information about your assay such as operator information, start and stop times, and barcodes, use the lab tracking form provided at www.illumina.com/documentation. This form can be filled out and saved online, or printed and filled in by hand.

Steps to Make the BCD Plate

Day 1

The following steps are intended only to provide an overview of the process. For specific instructions, use the manufacturer documentation.

- 1 Follow the instructions in the Zymo EZ DNA Methylation Kit to denature the genomic DNA and add conversion reagent.
- 2 Incubate in a thermal cycler using the following conditions for 16 cycles:
 - 95°C for 30 seconds
 - 50°C for 1 hour

**NOTE**

Denaturation is necessary for bisulfite conversion because the conversion reagent only works on single-stranded DNA.

- 3 Hold DNA at 4°C for 10 minutes in the thermal cycler until you are ready to do the clean-up.

Day 2

- 1 Follow the instructions in the Zymo EZ DNA Methylation Kit to do the following:

- a Clean the samples using the provided spin columns or filter plate. Wash off the remaining conversion reagent.



NOTE

When using the Zymo EZ DNA Methylation Kit, centrifuge the plate to between 3000 and 5000 × g for optimal performance.

- b Desulphonate the column or plate with desulphonation buffer. Incubate at room temperature for 15 minutes.
- c Clean the samples and wash twice to remove the desulphonation buffer.
- d Add elution buffer:
 - 12 µl for manual process from 500 ng gDNA
 - 22 µl for automated process from 1 µg of gDNA
- e Centrifuge to elute.



NOTE

When using the Zymo EZ DNA Methylation Kit, centrifuge the plate to between 3000 and 5000 × g for 5 minutes for optimal performance.

- 2 Transfer the bisulfite-converted DNA (BCD) samples to the BCD plate.
- 3 On the lab tracking form, record the WG#-BCD and BCD plate barcodes.
- 4 Heat-seal the plate and store it at -25°C to -15°C. Thaw the plate completely and vortex to mix contents before using it in an assay.



CAUTION

Do not store BCD for more than one month at -25°C to -15°C.



SAFE STOPPING POINT

Now is a good stopping point in the process.

Prepare BCD Plate



NOTE

Do not perform this preparation step for the FFPE version of this protocol.

- 1 Retrieve your BCD samples and thaw to room temperature.
- 2 Apply a BCD barcode label to a new 0.8 ml microtiter storage plate (MIDI) or a new 0.2 ml skirted microplate (TCY).

- 3 Dispense BCD according to the following figure:
 - Midi plate: 20 μ l BCD sample to each well (requires ≥ 1000 ng input in bisulfite conversion)
 - TCY plate: 10 μ l BCD sample to each well (requires ≥ 500 ng input in bisulfite conversion)

Figure 19 BCD Plate Sample Well Distribution

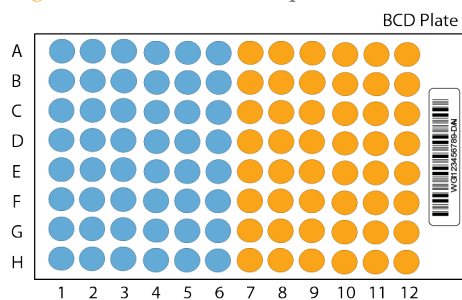

The example shown in this figure applies to 96 samples. For 48 samples, fill the first half of the plate only (blue shaded section).

Make MSA4 Plate (Pre-Amp)

This process creates an MSA4 plate for BCD amplification. MA1 is first added to the MSA4 plate, followed by the BCD samples. Next, the 0.1N NaOH is added to denature the BCD samples. The RPM reagent neutralizes the sample. Lastly, Multi-Sample Amplification Master Mix (MSM) is added to the plate.

Figure 20 Denaturing and Neutralizing BCD

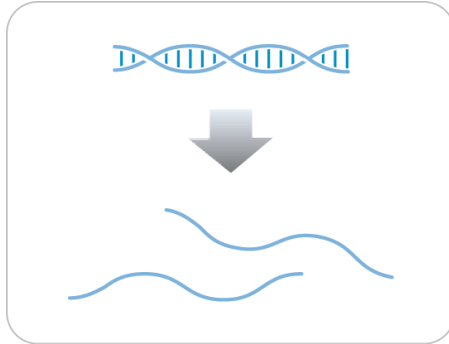

Estimated Time

Hands-on time:

- 45 minutes for 48 samples
- 60 minutes for 96 samples

Consumables

Item	Quantity	Storage	Supplied By
MA1	2 tubes (per 96 samples)	Room temperature	Illumina
RPM	2 tubes (per 96 samples)	-25°C to -15°C	Illumina

Item	Quantity	Storage	Supplied By
MSM	2 tubes (per 96 samples)	-25°C to -15°C	Illumina
0.1N NaOH	15 ml (per 96 samples)	2°C to 8°C	User
96-well 0.8 ml microplate (MIDI)	1 plate		User
BCD plate with Bisulfite- converted DNA samples	1 plate	-25°C to -15°C	User

**NOTE**

There are excess reagents provided in a 24-sample kit. Discard leftover reagents.

**NOTE**

Thaw all reagents completely at room temperature and allow to equilibrate. After thawed, gently invert each tube several times to mix the reagent thoroughly. Pulse centrifuge each tube to $280 \times g$ to eliminate bubbles and collect reagent at the bottom of the tube.

Preparation

- ▶ In preparation for the Incubate MSA4 process, preheat the Illumina Hybridization Oven in the post-amp area to 37°C and allow the temperature to equilibrate.
- 1 Apply an MSA4 barcode label to a new 0.8 ml microplate (MIDI).
 - 2 Thaw MA1, RPM, and MSM tubes to room temperature. Gently invert at least 10 times to mix contents.
 - 3 Thaw BCD samples to room temperature.
 - ▶ In the sample sheet, enter the Sample_Name and Sample_Plate for each Sample_Well.
 - ▶ On the lab tracking form, record:
 - Date/Time
 - Operator
 - BCD plate barcode
 - MSA4 plate barcodes
 - MA1 tube barcodes
 - RPM tube barcodes

- MSM tube barcodes



NOTE

To record information about your assay such as operator information, start and stop times, and barcodes, use the lab tracking form provided at www.illumina.com/documentation. This form can be filled out and saved online, or printed and filled in by hand.

Steps to Make MSA4 Plate

- 1 Dispense 20 μ l MA1 into the MSA4 plate wells.
- 2 Transfer 4 μ l of the DNA sample from the WG#-BCD plate to the corresponding wells in the MSA4 plate.
- 3 On the lab tracking form, record the original DNA sample ID for each well in the MSA4 plate.
- 4 Dispense 4 μ l 0.1N NaOH into each well of the MSA4 plate that contains MA1 and sample.

Refer to the following figure throughout the Make MSA4 process.

Figure 21 Distributing Sample to Wells

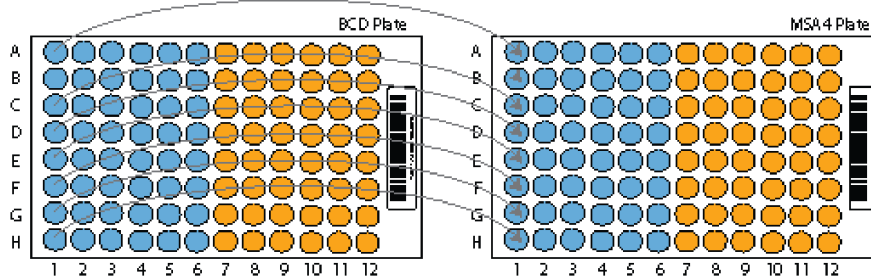

NOTE

To ensure optimal performance, exchange tips between DNA samples and use aerosol filter tips when pipetting DNA.

- 5 Seal the MSA4 plate with the 96-well cap mat.



CAUTION

Orient the cap mat so that A1 on the cap matches A1 on the plate. To prevent evaporation and spills, which could lead to assay variability and cross-contamination, make sure that all 96 caps are securely seated.

- 6 Vortex the plate at 1600 rpm for 1 minute.
- 7 Pulse centrifuge at $280 \times g$.
- 8 Incubate for 10 minutes at room temperature.
- 9 Carefully remove the cap mat.
When you remove a cap mat, set it aside, upside down, in a safe location for use later in the protocol.
- 10 Dispense 68 μ l RPM into each well of the MSA4 plate containing sample.
 **NOTE**
To ensure optimal performance, place the tips against the top edge of the wells. Use this technique for all subsequent dispensing steps.
- 11 Dispense 75 μ l MSM into each well of the MSA4 plate containing sample.
- 12 Seal MSA4 plate with cap mat.
When you place the cap mat back on the plate, be sure to match it to its original plate and orient it correctly.
- 13 Vortex the sealed MSA4 plate at 1600 rpm for 1 minute.
- 14 Pulse centrifuge at $280 \times g$.
- 15 Discard unused reagents in accordance with facility standards.
- 16 Proceed immediately to the next step.

Incubate MSA4 Plate

This process incubates the MSA4 plate for 20–24 hours at 37°C in the Illumina Hybridization Oven. It generates a sufficient quantity of each individual DNA sample to be used twice in the Infinium HD Assay for Methylation.

Figure 22 Incubating DNA to Amplify

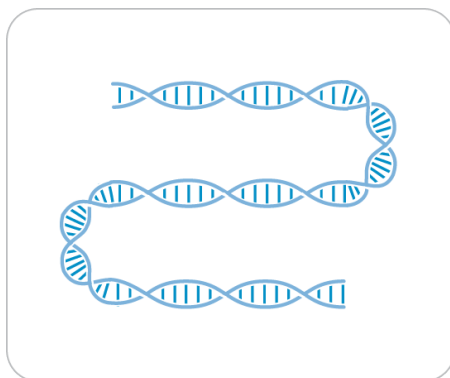

Estimated Incubation Time

20–24 hours

Steps to Incubate the MSA4 Plate



OVERNIGHT INCUBATION

Incubate the MSA4 plate in the Illumina Hybridization Oven for at least 20 hours but no more than 24 hours at 37°C.

- 1 Record the start and stop times on the lab tracking form.



NOTE

To record information about your assay such as operator information, start and stop times, and barcodes, use the lab tracking form provided at www.illumina.com/documentation. This form can be filled out and saved online, or printed and filled in by hand.

- 2 Proceed to the next step, *Fragment DNA (Post-Amp)*.

Fragment DNA (Post-Amp)

This process enzymatically fragments the amplified DNA samples. An endpoint fragmentation is used to prevent overfragmentation.

Figure 23 Fragmenting DNA

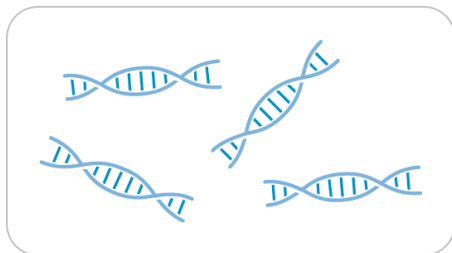

Estimated Time

Hands-on time: ~30 minutes for 96 samples

Incubation time: 1 hour

Consumables

Item	Quantity	Storage	Supplied By
FMS	2 tubes (per 96 samples)	-25°C to -15°C	Illumina

Preparation

- 1 Preheat the heat block with the midi plate insert to 37°C.
- 2 Thaw FMS tubes to room temperature.
- 3 Gently invert the FMS tubes at least 10 times to mix contents.
- 4 Remove the MSA4 plate from the Illumina Hybridization Oven.
- 5 On the lab tracking form, record:
 - Date/Time
 - Operator

- FMS tube barcodes



NOTE

To record information about your assay such as operator information, start and stop times, and barcodes, use the lab tracking form provided at www.illumina.com/documentation. This form can be filled out and saved online, or printed and filled in by hand.

Steps to Fragment the MSA4 Plate

- 1 Pulse centrifuge the plate at $280 \times g$.
- 2 Carefully remove the cap mat.
- 3 Add 50 μ l FMS to each well containing sample.
- 4 Seal the MSA4 plate with the 96-well cap mat.



CAUTION

Orient the cap mat so that A1 on the cap matches A1 on the plate. To prevent evaporation and spills, which could lead to assay variability and cross-contamination, make sure that all 96 caps are securely seated in the wells.

- 5 Vortex the plate at 1600 rpm for 1 minute.
- 6 Pulse centrifuge the plate to $280 \times g$.
- 7 Place the sealed plate on the 37°C heat block for 1 hour.
- 8 Record the start and stop times on the lab tracking form.
- 9 Discard unused reagents in accordance with facility standards.
- 10 Do either of the following:
 - Continue to the next step, *Precipitate DNA (Post-Amp)*. Leave plate in 37°C heat block until setup is complete. Do not leave the plate in the 37°C heat block for longer than 2 hours.
 - If you do not plan to proceed to the next step within the next 4 hours, store the sealed MSA4 plate at -25°C to -15°C for no more than 24 hours.



SAFESTOPPING POINT

Now is a good stopping point in the process.

Precipitate DNA (Post-Amp)

Add PM1 and 2-propanol to the MSA4 plate to precipitate the DNA samples.

Figure 24 Precipitating DNA

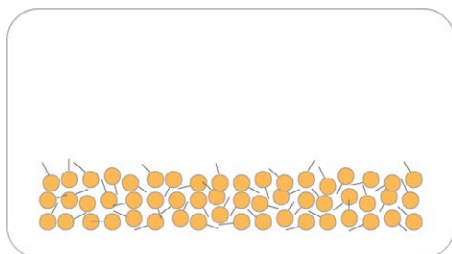

Estimated Time

Hands-on time: ~30 minutes

Incubation and dry time: 2 hours

Consumables

Item	Quantity	Storage	Supplied By
PM1	2 tubes (per 96 samples)	2°C to 8°C	Illumina
100% 2-propanol	40 ml (per 96 samples)	Room temperature	User
Adsorbent pad	1	Room temperature	User



CAUTION

Pour only the recommended reagent volume needed for the suggested number of samples listed in the Consumables table of each section. Some reagents are used later in the protocol.

Preparation

- 1 Do either of the following:

- If you froze the MSA4 plate after fragmentation, thaw it to room temperature, then pulse centrifuge the plate to $280 \times g$.
 - If you proceeded immediately from *Fragment the MSA4 Plate*, leave the plate in the 37°C heat block until setup is complete.
- 2 Preheat heat block to 37°C .
 - 3 Thaw PM1 to room temperature. Gently invert at least 10 times to mix contents.
 - 4 Remove the 96-well cap mat.
 - ▶ On the lab tracking form, record:
 - Date/Time
 - Operator
 - PM1 tube barcodes
 - 2-propanol lot number and date opened



NOTE

To record information about your assay such as operator information, start and stop times, and barcodes, use the lab tracking form provided at www.illumina.com/documentation. This form can be filled out and saved online, or printed and filled in by hand.

Steps to Precipitate the MSA4 Plate

- 1 Add $100 \mu\text{l}$ PM1 to each MSA4 plate well containing sample.
- 2 Seal the plate with the cap mat.
- 3 Vortex the plate at 1600 rpm for 1 minute.
- 4 Incubate at 37°C for 5 minutes.
- 5 Pulse centrifuge at $280 \times g$ for 1 minute.
 - ▶ NOTE
 - Set the centrifuge at 4°C in preparation for the next centrifuge step.
- 6 Carefully remove the cap mat and discard it.
- 7 Add $300 \mu\text{l}$ 100% 2-propanol to each well containing sample.
- 8 Carefully seal the MSA4 plate with a new, *dry* cap mat, taking care not to shake the plate in any way until the cap mat is fully seated.
- 9 Invert the plate at least 10 times to mix contents thoroughly.

- 10 Incubate at 4°C for 30 minutes.
- 11 Place the sealed MSA4 plate in the centrifuge opposite another plate of equal weight.

Figure 25 Sealed MSA4 Plate and Plate of Equal Balance in Centrifuge

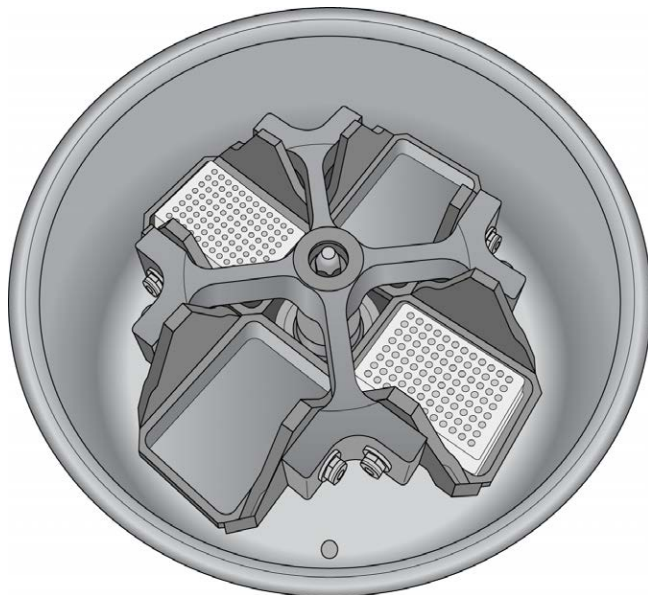

- 12 Centrifuge at $3000 \times g$ at 4°C for 20 minutes. Immediately remove the MSA4 plate from centrifuge.



CAUTION

Perform the next step immediately to avoid dislodging the blue pellet. If any delay occurs, repeat the 20-minute centrifugation before proceeding.

- 13 Remove the cap mat and discard it.
- 14 Quickly invert the MSA4 plate and drain the liquid onto an absorbent pad to decant the supernatant. Then smack the plate down on a dry area of the pad, avoiding the liquid that was drained onto the pad.
- 15 Tap firmly several times for 1 minute or until all wells are devoid of liquid.



CAUTION

Keep the plate inverted. To ensure optimal performance, do not allow supernatant in wells to pour into other wells.

- 16 Leave the uncovered, inverted plate on the tube rack for 1 hour at room temperature to air dry the pellet.

You can expect to see blue pellets at the bottoms of the wells.

Figure 26 Uncovered MSA4 Plate Inverted for Air Drying

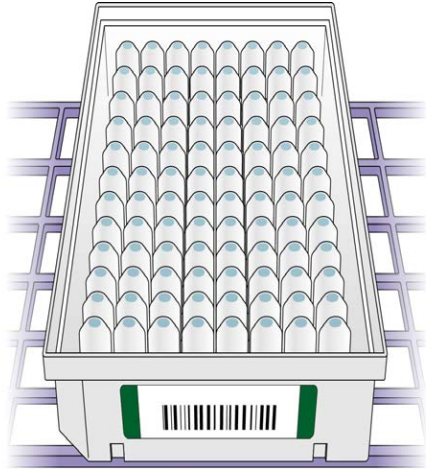

CAUTION

Do not overdry the pellet. Pellets that are overdried are difficult to resuspend. Poorly resuspended samples lead to poor data quality.

- 17 Enter the start and stop times on the lab tracking form.
- 18 Discard unused reagents in accordance with facility standards.
- 19 Do either of the following:
 - Continue to the next step, *Resuspend DNA (Post-Amp)*.
 - If you do not plan to proceed to the next step immediately, seal the MSA4 plate with a new cap mat and store it at -25°C to -15°C .



SAFESTOPPING POINT

Now is a good stopping point in the process.

Resuspend DNA (Post-Amp)

Add RA1 to the MSA4 plate to resuspend the precipitated DNA samples.

Figure 27 Resuspending DNA

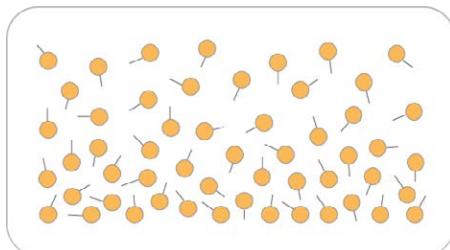

Estimated Time

Hands-on time: ~30 minutes

Incubation time: 1 hour

Consumables

Item	Quantity	Storage	Supplied By
RA1	46 μ l per sample well	-25°C to -15°C	Illumina



NOTE

Pour out only the recommended volume of RA1 needed for the suggested number of samples listed in the consumables table. Additional RA1 can be stored at -20°C to be used later in the **XStain BeadChip** step.



WARNING

This protocol uses an aliphatic amide that is a probable reproductive toxin. Personal injury can occur through inhalation, ingestion, skin contact, and eye contact. For more information, consult the material data safety sheet for this assay at www.illumina.com/msds. Dispose of containers and any unused contents in accordance with the governmental safety standards for your region.

Preparation

- 1 If you stored the MSA4 plate at -25°C to -15°C, thaw it to room temperature. Remove the cap mat and discard it.
- 2 Preheat the Illumina Hybridization Oven to 48°C.
- 3 Turn on the heat sealer to preheat. Allow 20 minutes.
- 4 RA1 is shipped frozen. Gradually warm the reagent to room temperature, preferably in a 20°C to 25°C water bath. Gently mix to dissolve any crystals that can be present.
- 5 On the lab tracking form, record:
 - Date/Time
 - Operator
 - RA1 bottle barcodes



NOTE

To record information about your assay such as operator information, start and stop times, and barcodes, use the lab tracking form provided at www.illumina.com/documentation. This form can be filled out and saved online, or printed and filled in by hand.

Use Fresh RA1 Reagent for Each Step

It is important to use fresh RA1 for each protocol step in the assay where it is required. RA1 that has been stored properly and has not been dispensed for use in either the XStain or Resuspension step is considered fresh RA1. After RA1 has been poured out into a reservoir and exposed to room temperature air for extended periods of time, it is no longer fresh.

To make best use of RA1, only pour out the amount needed for the current step. If you plan to perform additional assay steps requiring RA1 that same day, then leave the remaining thawed reagent in the original, closed bottle at room temperature until it is needed. Otherwise, follow the standard RA1 storage procedures described in this assay guide for next-day processing and prolonged storage conditions.

Steps to Resuspend the MSA4 Plate

- 1 Add 46 µl RA1 to each well of the MSA4 plate containing a DNA pellet. Reserve any leftover reagent for the Hybridization and XStain steps.

- 2 Apply a foil heat seal to the MSA4 plate by firmly and evenly holding the heat sealer sealing block down for 3 seconds.
- 3 Immediately remove the MSA4 plate from the heat sealer and forcefully roll the rubber plate sealer over the plate until you can see all 96 well indentations through the foil. Repeat application of the heat sealer if all 96 wells are not defined.
- 4 Place the sealed plate in the Illumina Hybridization Oven and incubate for 1 hour at 48°C.
- 5 Vortex the plate at 1800 rpm for 1 minute.
- 6 Pulse centrifuge at 280 × g.

**NOTE**

If you store the pellets at -25°C to -15°C for extended periods of time after the precipitation, you might need to revortex and recentrifuge until the pellets are resuspended.

- 7 Discard unused reagents in accordance with facility standards.
- 8 Do either of the following:
 - Continue to the next step, *Hybridize to BeadChip (Post-Amp)*. If you plan to do so immediately, it is safe to leave the MSA4 plate at room temperature for up to 1 hour.
 - If you do not plan to proceed to the next step immediately, store the sealed MSA4 plate at -25°C to -15°C for no more than 24 hours. Store RA1 at -25°C to -15°C.

**SAFE STOPPING POINT**

Now is a good stopping point in the process.

Hybridize to BeadChip (Post-Amp)

In this process, you dispense the fragmented and resuspended DNA samples onto BeadChips. Place the DNA-loaded BeadChips into the Hyb Chamber inserts, and then place the inserts into the Hyb Chambers. Incubate the Hyb Chambers in the Illumina Hybridization Oven for 16–24 hours at 48°C.

Figure 28 Hybridize to BeadChip

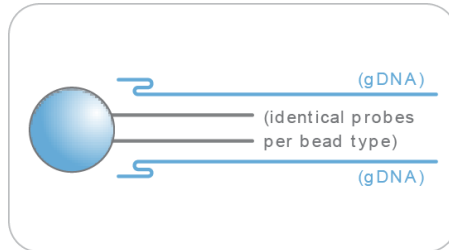

Estimated Time

Hands-on time:

- ~30 minutes for 48 samples
- ~40 minutes for 96 samples

Incubation time: 16–24 hours

Consumables for 8x1 HD BeadChip

Item	Quantity (per 96 Samples)	Storage	Supplied By
PB2	2 tubes	Room temperature	Illumina
BeadChips	12		Illumina
Hyb Chambers	3		Illumina
Hyb Chamber gaskets	3		Illumina

Item	Quantity (per 96 Samples)	Storage	Supplied By
Hyb Chamber inserts	12		Illumina
EtOH	330 ml		User

Consumables for 12x1 HD BeadChip

Item	Quantity (per 96 Samples)	Storage	Supplied By
PB2	2 tubes	Room temperature	Illumina
BeadChips	8		Illumina
Hyb Chambers	2		Illumina
Hyb Chamber gaskets	2		Illumina
Hyb Chamber inserts	8		Illumina
EtOH	500 ml		User



NOTE

Thaw all reagents completely at room temperature and allow to equilibrate. After thawed, gently invert each tube several times to mix the reagent thoroughly. Pulse centrifuge each tube to $280 \times g$ to eliminate bubbles and collect reagent at the bottom of the tube.

Preparation

- 1 Preheat the heat block to 95°C.
- 2 Prepare the Illumina Hybridization Oven as follows:
 - a Preheat the oven to 48°C:
 - Press the "F" button one time to change the display to **TSET**.
 - Press the "S" button to enter the set-temperature mode, and then use the Increment/Decrement dial to set the oven to 48°C.

- Press the "S" button again to set 48°C as the temperature.
 - b Set the rocker speed to 5:
 - Press the "F" button twice until **SPd** is indicated on the display.
 - Press the "S" button to enter the rocker speed mode.
 - Use the Increment/Decrement dial to set the rocker speed to "5".
 - Press the "S" button again.
- 3 Calibrate the Illumina Hybridization Oven with the Full-Scale Plus digital thermometer supplied with your system.
- 4 On the lab tracking form, record:
 - Date/Time
 - Operator
 - PB2 tube lot number

**NOTE**

To record information about your assay such as operator information, start and stop times, and barcodes, use the lab tracking form provided at www.illumina.com/documentation. This form can be filled out and saved online, or printed and filled in by hand.

Assemble the Hybridization Chambers

- 1 Place the resuspended MSA4 plate on the heat block to denature the samples at 95°C for 20 minutes.
- 2 Remove the BeadChips from 2°C to 8°C storage, leaving the BeadChips in their plastic bags and mylar packages until you are ready to begin hybridization.
- 3 During the 20-minute incubation, prepare the Hyb Chambers.
Place the following items on the benchtop for use in this procedure:

Figure 29 BeadChip Hyb Chamber Components

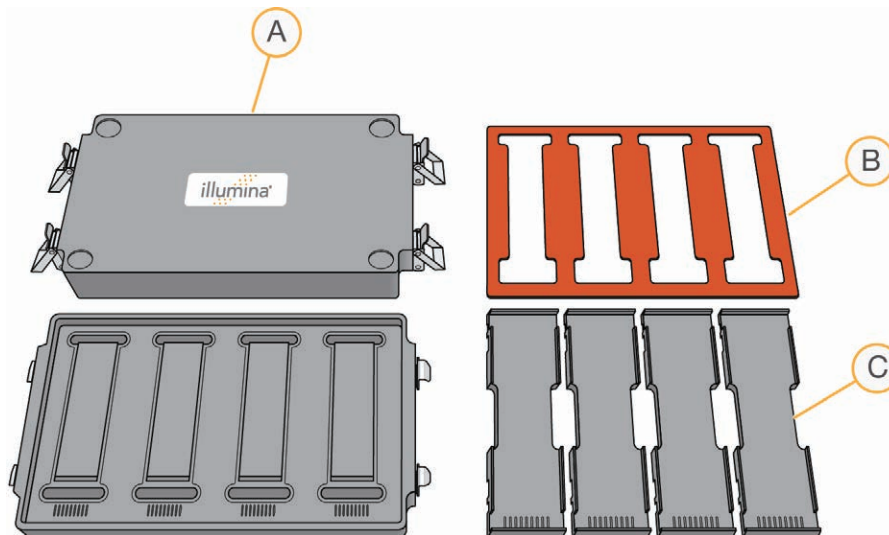

- A BeadChip Hyb Chambers
- B Hyb Chamber Gaskets
- C Hyb Chamber Inserts



NOTE

To ensure optimal results from Hyb Chambers, keep the Hyb Chamber lids and bases together. Adopt a labeling convention that keeps each Hyb Chamber base paired with its original lid. Check Hyb Chamber lid-base pairs regularly to make sure that the fit remains secure. Check hinges regularly for any signs of abnormal wear or loose fittings. It is important that the hinges provide adequate clamping strength to ensure an airtight seal between the lid and the base. Record the Hyb Chamber that was used for each BeadChip, so that Hyb Chambers can be investigated and evaluated in the event of sample evaporation or other lab processing anomalies.

- a Place the BeadChip Hyb Chamber gaskets into the BeadChip Hyb Chambers.
 - Match the wider edge of the Hyb Chamber Gasket to the barcode-ridge of the Hyb Chamber.

Figure 30 Hyb Chamber and Gasket

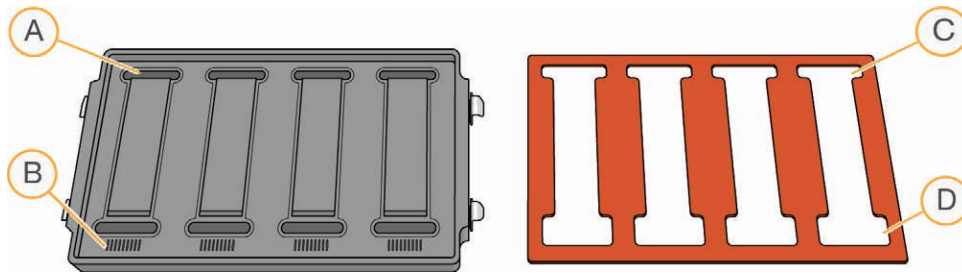

- A Reservoirs
- B Barcode Ridges
- C Narrower Edges
- D Wider Edges

- Lay the gasket into the Hyb Chamber, and then press it down all around.

Figure 31 Placing Gasket into Hyb Chamber



- Make sure that the Hyb Chamber gaskets are properly seated.

Figure 32 Hyb Chamber with Gasket in Place

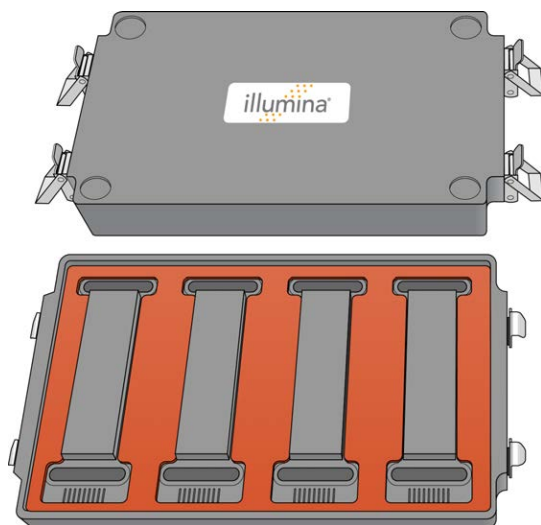

- b Dispense 400 μ l PB2 into the humidifying buffer reservoirs in the Hyb Chambers.

Figure 33 Dispensing PB2 into Hyb Chamber Reservoir

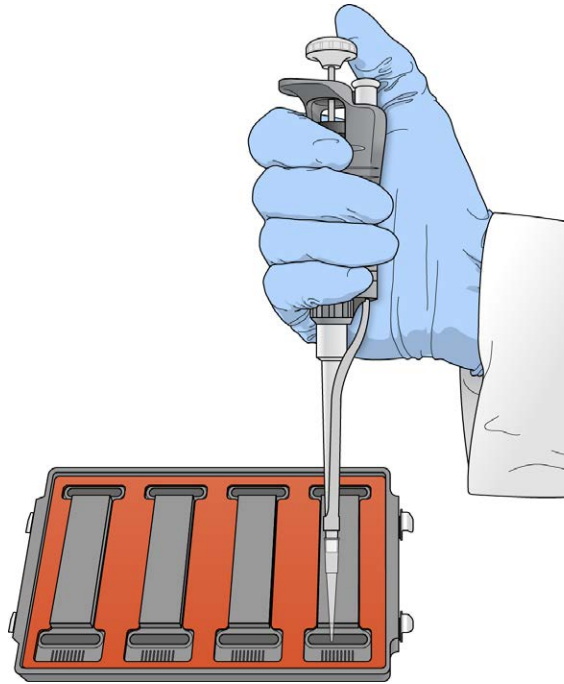

WARNING

Do not replace PB2 in the Hyb Chamber with RA1. RA1 decreases the stringency and can negatively affect sample call rates and logRdev. PB2 is formulated to produce the appropriate amount of humidity within the Hyb Chamber environment to prevent sample from evaporating during hybridization.

- c After you fill the Hyb Chamber reservoirs with PB2, place the lid on the Hyb Chamber right away to prevent evaporation. It is not necessary to lock the lid.
- d Leave the closed Hyb Chambers on the bench at room temperature until the BeadChips are loaded with DNA sample. Load BeadChips into the Hyb Chamber within 1 hour.



NOTE

You can also prepare the Hyb Chambers later, during the 30-minute cool down.

- 4 After the 20-minute incubation, remove the MSA4 plate from the heat block and place it on the benchtop at room temperature for 30 minutes.

- 5 After the 30-minute cool down, pulse centrifuge the MSA4 plate to $280 \times g$. Remove the foil seal.

Load BeadChip

- 1 Just before loading DNA samples, remove all BeadChips from their plastic bags and mylar packages.



CAUTION

Hold the BeadChip by the ends with your thumb and forefinger (thumb at the barcode end). Do not hold the BeadChip by the sides near the sample inlets. Avoid contacting the beadstripe area and sample inlets.

- 2 Place each BeadChip in a Hyb Chamber insert, orienting the barcode end so that it matches the barcode symbol on the Hyb Chamber insert.

Figure 34 Placing BeadChips into Hyb Chamber Inserts

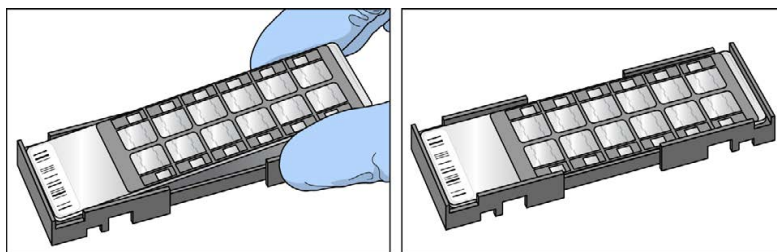

NOTE

For an alternative DNA loading protocol, see Load BeadChip (Alternate Method).

For the 8x1 BeadChip

- 1 Using a single-channel precision pipette, dispense 26 μ l of each DNA sample onto the appropriate BeadChip section, according to the chart. Make sure that the pipette tip is in the sample inlet before dispensing.

Follow the color-coded sections shown in the chart on the following page for sample loading assistance.

- a Load sample A1 from the MSA4 plate into sample inlet A1 of the BeadChip. Make sure that the pipette tip is in the sample inlet before dispensing.
- b Load sample B1 from the MSA4 plate into sample inlet B1 of the BeadChip.
- c Load sample C1 from the MSA4 plate into sample inlet C1 of the BeadChip.
- d Load sample D1 from the MSA4 plate into sample inlet D1 of the BeadChip.
- e Continue in this manner until all samples are loaded.

Figure 35 Distributing Sample in the MSA4 Plate

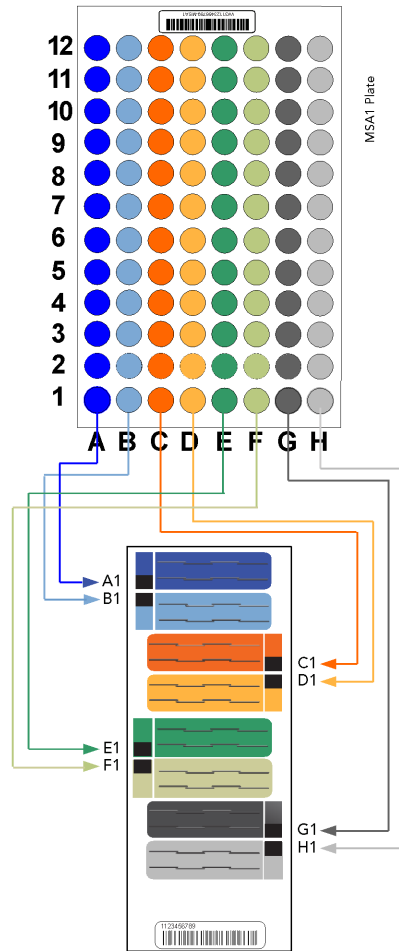

For the 12x1 BeadChip

- 2 Using a multichannel precision pipette, dispense 15 μ l of each DNA sample onto the appropriate BeadChip section.

Figure 36 Loading Samples

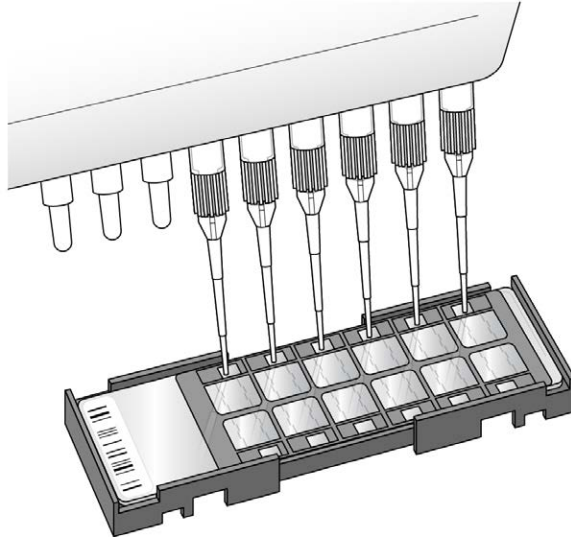

- a Load samples A1–F1 from the MSA4 plate into the left side of the BeadChip. Make sure that the pipette tip is in the sample inlet before dispensing.
- b Load samples in G1 and H1 from the MSA4 plate into the top 2 inlets of the right side of the BeadChip.
- c Load samples A2–D2 into the remaining 4 inlets on the right side of the BeadChip.
- d Continue in this manner, following the color-coded sections in the chart, until all samples are loaded.

Figure 38 Bolus of Liquid at Loading Port

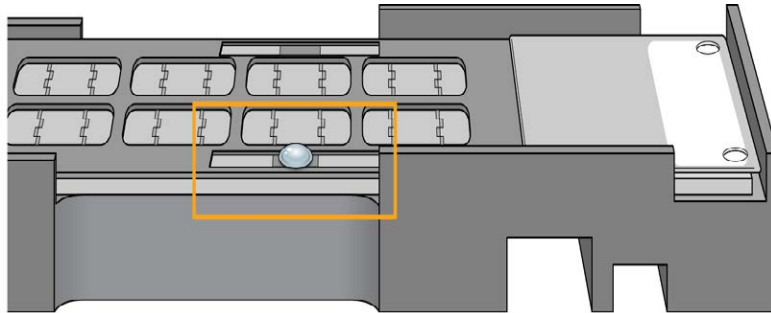

- 7 If no excess liquid is visible, it is acceptable to add additional sample from the leftover volume in the amplification plate until there is a large bolus around the loading port.



NOTE

Do not add extra RA1, because too much RA1 dilutes the sample.

- 8 Record the top-up activity on the lab tracking form.
- 9 Heat-seal any residual sample in the MSA4 plate with foil, and store at -25°C to -15°C . Store at -80°C if you do not plan to use the sample again within 24 hours.

Set up BeadChip for Hybridization



CAUTION

For optimal performance, take care to keep the Hyb Chamber inserts containing BeadChips steady and level when lifting or moving. Avoid shaking and always keep parallel to the lab bench. Do not hold by the sides near the sample inlets.

- 1 Load the Hyb Chamber inserts containing BeadChips into the Illumina Hyb Chamber. Position the barcode end over the ridges indicated on the Hyb Chamber.



WARNING

Keep Hyb Chambers at room temperature when you load the BeadChips. Do not place the Hyb Chambers in the Illumina Hybridization Oven before loading the BeadChips. If you heat the PB2 and then open the Hyb Chamber to add BeadChips, some of the PB2 evaporates, leading to a change in the osmolality of PB2 and an imbalance in the vapor pressure between PB2 and RA1.

Figure 39 Placing Hyb Chamber Inserts into the Hyb Chamber

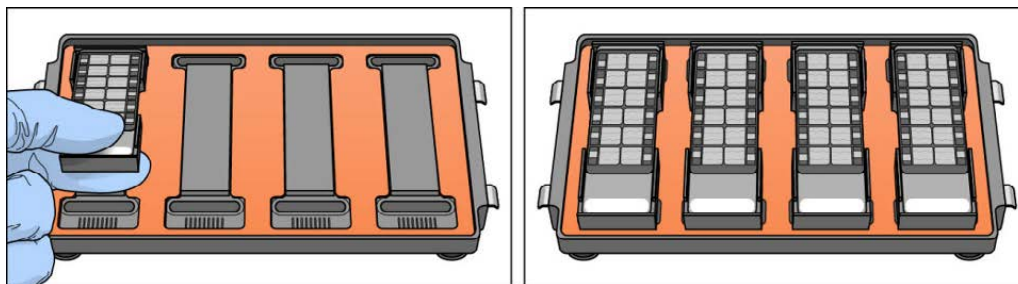

- 2 Place the back side of lid onto the Hyb Chamber and then slowly bring down the front end to avoid dislodging the Hyb Chamber inserts.

Figure 40 Seating Lid onto Hyb Chamber

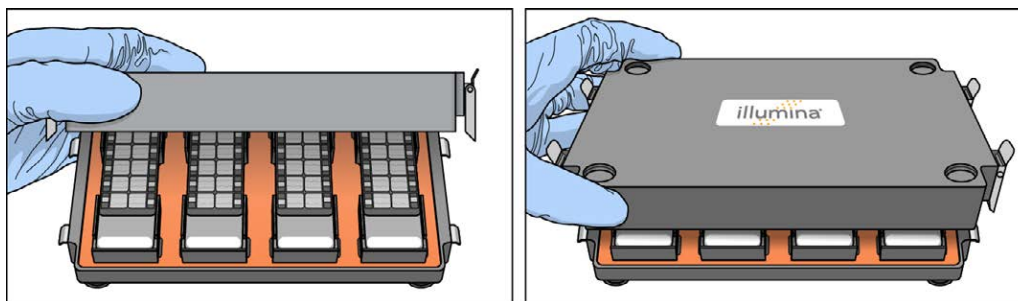

- 3 Close the clamps on both sides of the Hyb Chamber so that the lid is secure and even on the base (no gaps). It is best to close the clamps in a kitty-corner fashion, closing first the top left clamp, then the bottom right, then the top right followed by the bottom left.

**NOTE**

Keep the Hyb Chamber steady and level when moving it or transferring it to the Illumina Hybridization Oven.

- 4 Place the Hyb Chamber in the 48°C Illumina Hybridization Oven with the clamps on the left and right sides of the oven and the Illumina logo facing you.

**CAUTION**

After loading the BeadChips into the Hyb Chambers, place the Hyb Chambers into the Illumina Hybridization Oven immediately. Do not modify the hybridization environment by adding additional fixtures or humidifying elements. Leave the Hyb Chambers in the oven at the correct orientation and temperature until hybridization is complete. Changes to the hybridization environment can have unexpected effects on data quality.

Figure 41 Hyb Chamber Correctly Placed in Hyb Oven

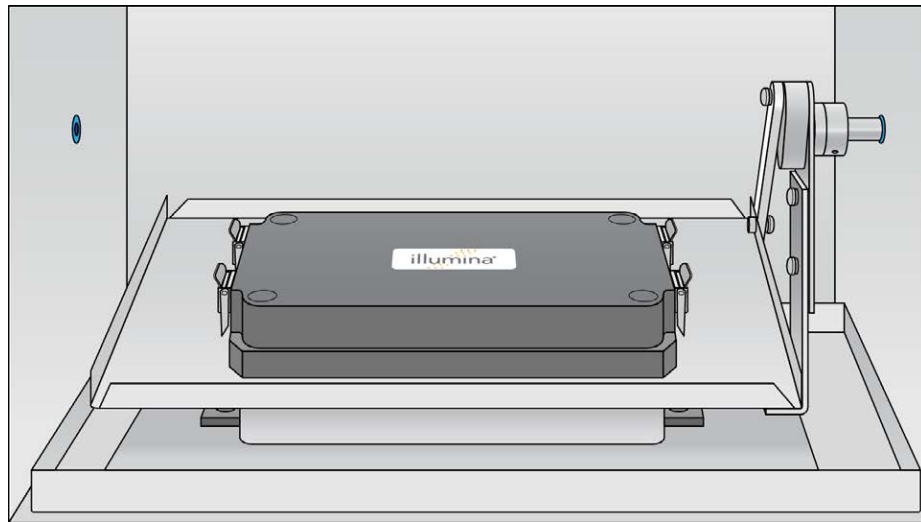
**NOTE**

If you are stacking multiple Hyb Chambers in the Illumina Hybridization Oven, fit the feet of the top Hyb Chamber into the matching indents on the lid of the Hyb Chamber below it. The fitted feet and lid hold the Hyb Chambers in place while they are rocking. You can stack up to 3 Hyb Chambers per row for a maximum of 6 Hyb Chambers total in the Illumina Hybridization Oven.

Figure 42 Two Hyb Chambers Correctly Placed in Hyb Oven

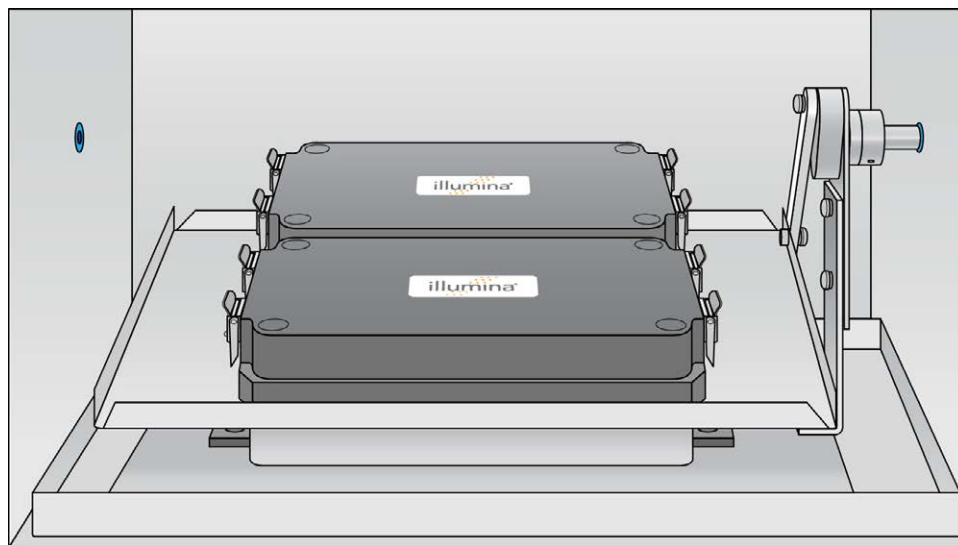
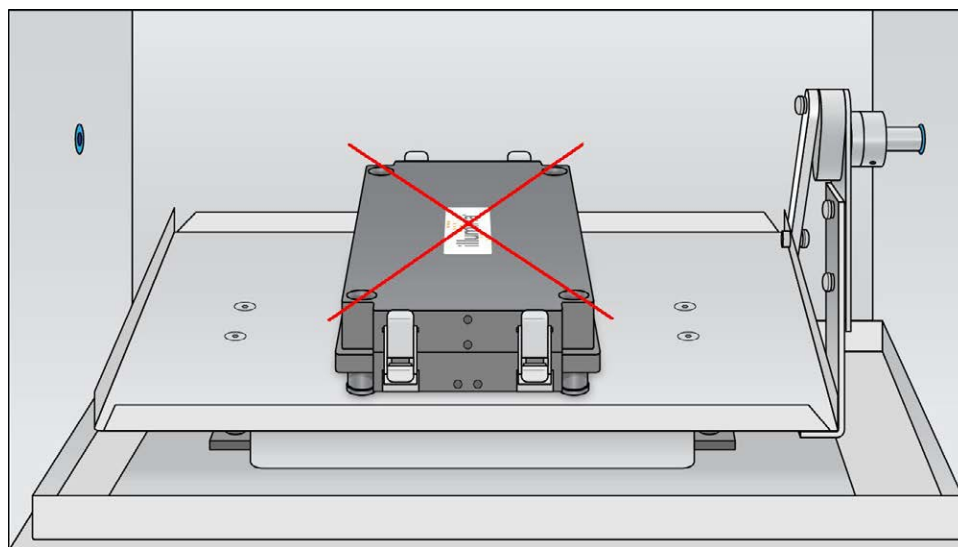

Figure 43 Incorrectly Placed Hyb Chamber



- 5 [Optional] Start the rocker, setting the speed to 5.

**OVERNIGHT INCUBATION**

Incubate at 48°C for at least 16 hours but no more than 24 hours.

- 6 Enter the start and stop times on the lab tracking form.
- 7 Place RA1 into the freezer at -25°C to -15°C for use the next day.
- 8 Proceed to *Wash BeadChips (Post-Amp)* after the overnight incubation.

Resuspend XC4 Reagent for XStain BeadChip

Keep the XC4 in the bottle in which it was shipped until you are ready to use it. In preparation for the XStain protocol, follow these steps to resuspend the XC4 reagent.

- 1 Add 330 ml 100% EtOH to the XC4 bottle, for a final volume of 350 ml.
Each XC4 bottle has enough solution to process up to 24 BeadChips.
- 2 Shake the XC4 bottle vigorously to ensure complete resuspension. After it is resuspended, use XC4 at room temperature.
You can store it at 2°C to 8°C for 2 weeks if unused.

Load BeadChip (Alternate Method)

This section describes an alternative method of manually loading the DNA by rows instead of columns from the MSA4 plate. For the original method of loading DNA samples, see *Load BeadChip* on page 60.

- 1 Just before loading DNA samples, remove all BeadChips from their plastic bags and mylar packages.

**CAUTION**

Hold the BeadChip by the ends with your thumb and forefinger (thumb at the barcode end). Do not hold the BeadChip by the sides near the sample inlets. Avoid contacting the beadstripe area and sample inlets.

- 2 Place each BeadChip in a Hyb Chamber insert, orienting the barcode end so that it matches the barcode symbol on the Hyb Chamber insert. Repeat for each BeadChip.

Figure 44 Placing BeadChips into Hyb Chamber Inserts

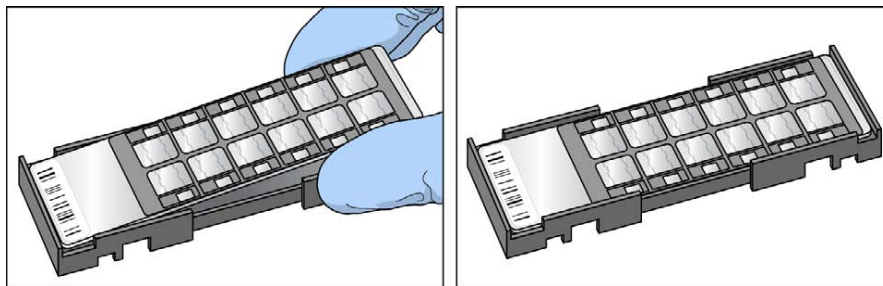

- 3 Using a multichannel precision pipette, dispense 15 μ l of each DNA sample onto the appropriate BeadChip section.

Figure 45 Loading Samples

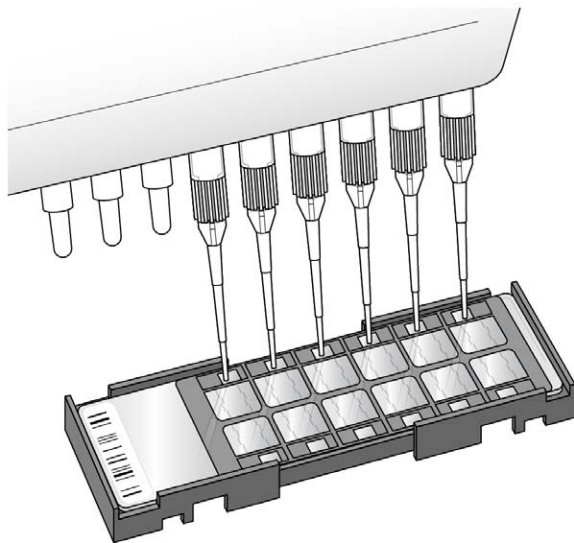

- a Load samples A1–A6 from the MSA4 plate to the left side of the BeadChip. Make sure that the pipette tip is in the sample inlet before dispensing.
- b Load samples B1–B6 from the MSA4 plate to the right side of the BeadChip.
- c Continue in this manner for Rows C through H.

- d When you finish the left half of the plate, move to the right half of the plate. Load samples A7–A12 to the left side of the BeadChip and samples B7–B12 to the right side of the BeadChip. Continue in this manner for rows C through H.

Figure 46 Alternate Distributing Sample in MSA4 Plate

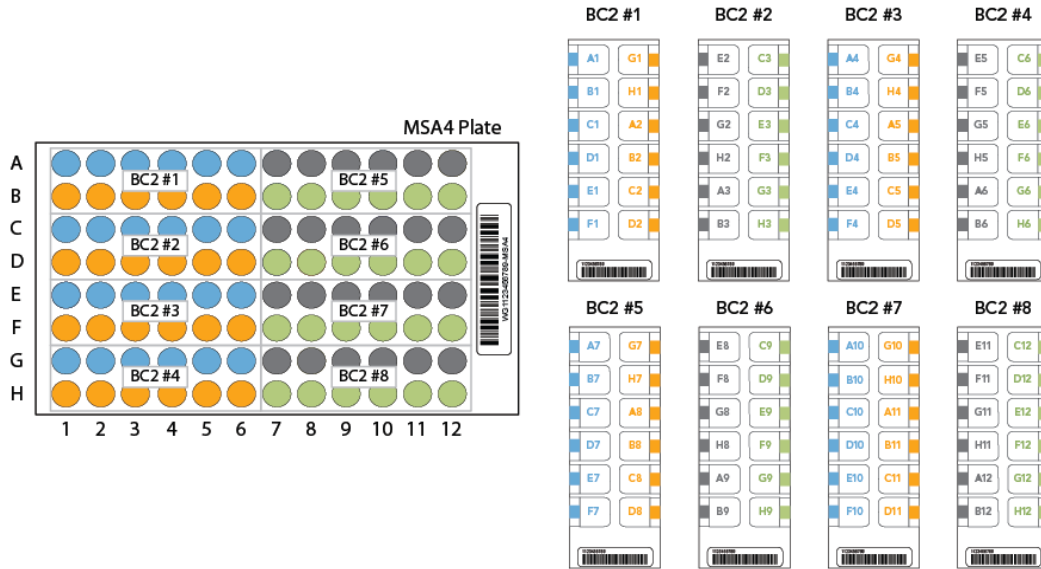

- 4 On the lab tracking form, record the BeadChip barcode for each group of samples.
- 5 In the sample sheet, record the sample ID and position on the BeadChip in the Sentrix ID column. See the Sample Section Naming Diagram in the Lab Tracking Form.
- 6 Inspect all sections of the BeadChips to make sure that the DNA sample covers all sections of each bead stripe. Record any sections that are not completely covered on the lab tracking form.
- 7 Heat-seal residual sample in the MSA4 plate with foil and store at -25°C to -15°C. Store at -80°C if you do not plan to use it again within 24 hours.

Wash BeadChips (Post-Amp)

In this procedure, the BeadChips are prepared for the XStain process.

Remove the cover seals from the BeadChips and wash the BeadChips in 2 separate PB1 reagent washes. Then, assemble the BeadChips into flow-through chambers under the PB1 buffer.

Figure 47 Washing BeadChip

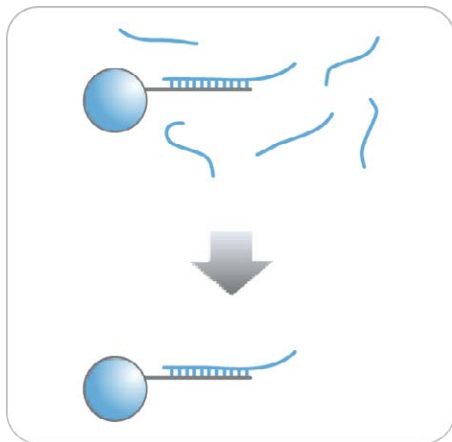

Estimated Time

- 20 minutes for 4 BeadChips
- 30 minutes for 8 BeadChips

Consumables

Item	Quantity	Storage	Supplied By
PB1	550 ml for 1 alignment fixture 700 ml for 2 alignment fixtures 850 ml for 3 alignment fixtures	Room temperature	Illumina
Multisample BeadChip alignment fixture	1 (per 8 BeadChips)		Illumina
Te-Flow flow-through chambers, with black frames, spacers, glass back plates, and clamps	1 (per BeadChip)		Illumina
Wash dish	2 (up to 8 BeadChips)		Illumina
Wash rack	1 (up to 8 BeadChips)		Illumina



CAUTION

Pour only the recommended reagent volume needed for the suggested number of samples listed in the Consumables table of each section. Some reagents are used later in the protocol.



WARNING

This protocol uses an aliphatic amide that is a probable reproductive toxin. Personal injury can occur through inhalation, ingestion, skin contact, and eye contact. For more information, consult the material data safety sheet for this assay at www.illumina.com/msds. Dispose of containers and any unused contents in accordance with the governmental safety standards for your region.

Preparation

- 1 Remove each Hyb Chamber from the Illumina Hybridization Oven. Let cool on the benchtop for 30 minutes before opening.
- 2 Have ready on the lab bench:
 - a Two wash dishes:
 - Containing 200 ml PB1, and labeled as such
 - b Multi-Sample BeadChip Alignment Fixture
 - Using a graduated cylinder, fill with 150 ml PB1
 - c Te-Flow flow-through chamber components:
 - Black frames
 - Spacers (separated for ease of handling)
 - Clean glass back plates as directed in the *Infinium Lab Setup and Procedures Guide*.
 - Clamps
- 3 On the lab tracking form, record:
 - Date/Time
 - Operator
 - PB1 bottle barcode



NOTE

To record information about your assay such as operator information, start and stop times, and barcodes, use the lab tracking form provided at www.illumina.com/documentation. This form can be filled out and saved online, or printed and filled in by hand.

Steps to Wash BeadChips

- 1 Attach the wire handle to the rack and submerge the wash rack in the wash dish containing 200 ml PB1.

Figure 48 Wash Rack in Wash Dish Containing PB1



- 2 Remove the Hyb Chamber inserts from the Hyb Chambers.
- 3 Remove each BeadChip from the Hyb Chamber insert.
- 4 Remove the cover seal from each BeadChip.



NOTE

To make sure that no solution splatters on you, Illumina recommends removing the cover seal over an absorbent cloth or paper towels, preferably in a hood.

- a Using powder-free gloved hands, hold the BeadChip securely and by the edges in one hand. Avoid contact with the sample inlets. Make sure that the barcode is facing up and closest to you, and that the top side of the BeadChip is angled slightly away from you.
- b Remove the entire seal in a single, continuous motion. Start with a corner on the barcode end and pull with a continuous upward motion away from you and towards the opposite corner on the top side of the BeadChip.

Figure 49 Removing the Cover Seal

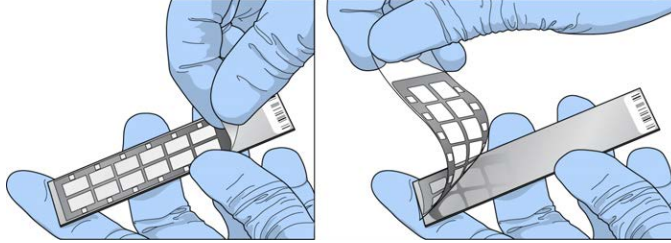

c Discard the cover seal.



CAUTION
Do not touch the arrays!

- 5 Immediately and carefully slide each BeadChip into the wash rack, making sure that the BeadChip is submerged in the PB1.

Figure 50 Submerging BeadChips in Wash Dish Containing PB1



- 6 Repeat steps 4 through 5 until all BeadChips (a maximum of 8) are transferred to the submerged wash rack.

- 7 After all BeadChips are in the wash rack, move the wash rack up and down for 1 minute, breaking the surface of the PB1 with gentle, slow agitation.
- 8 Move the wash rack to the other wash dish containing clean PB1. Make sure the BeadChips are submerged.
- 9 Move the wash rack up and down for 1 minute, breaking the surface of the PB1 with gentle, slow agitation.
- 10 When you remove the BeadChips from the wash rack, inspect them for remaining residue.

**NOTE**

Residue that can adversely affect results is sometimes left on BeadChips after seals are removed. If there is residue left on the BeadChips after the second PB1 wash, use a 200 μ l pipette tip to slowly and carefully scrape the residue away from the bead sections. Use a new pipette tip for each BeadChip. Then, continue with the protocol.

- 11 For each additional set of 8 BeadChips:
 - a Assemble the flow-through chambers for the first 8 BeadChips, as described in *Assemble Flow-Through Chambers* on page 78.
 - b Repeat the wash steps in this section to wash the next set of 8 BeadChips.

Assemble Flow-Through Chambers



NOTE

Confirm that you are using the correct Infinium standard glass back plates and spacers before assembling the flow-through chambers. Refer to the following image for the correct flow-through chamber components.

Figure 51 Correct Standard Back Plates and Spacers

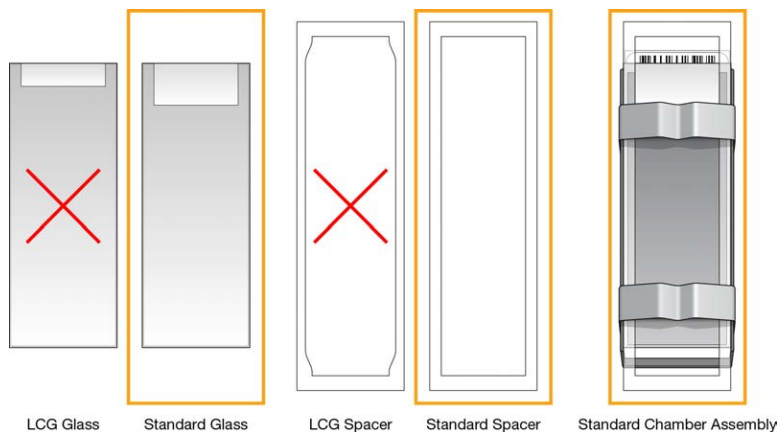

- 1 If you have not done so, fill the BeadChip alignment fixture with 150 ml PB1. If you plan to process more than 4 BeadChips, this 150 ml of PB1 can be reused for an additional set of 4 BeadChips. Use 150 ml of fresh PB1 for every additional set of 8 BeadChips.
- 2 For each BeadChip to be processed, place a black frame into the BeadChip alignment fixture prefilled with PB1.

Figure 52 Placing Black Frames into BeadChip Alignment Fixture



- 3 Place each BeadChip to be processed into a black frame, aligning its barcode with the ridges stamped onto the alignment fixture.



NOTE

Inspect the surface of each BeadChip for residue left by the seal. Use a pipette tip to remove any residue under buffer and be careful not to scratch the bead area.

Figure 53 Placing BeadChip into Black Frame on Alignment Fixture



- 4 Place a clear spacer onto the top of each BeadChip. Use the alignment fixture grooves to guide the spacers into proper position.

**NOTE**

Be sure to use the clear plastic spacers, not the white ones.

Figure 54 Placing Clear Plastic Spacer onto BeadChip

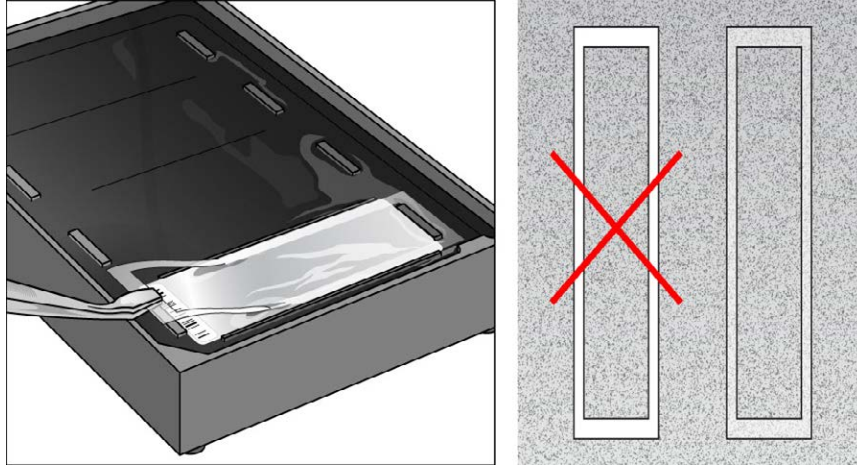

- 5 Place the alignment bar onto the alignment fixture.
The groove in the alignment bar fits over the tab on the alignment fixture.

Figure 55 Placing Alignment Bar onto Alignment Fixture

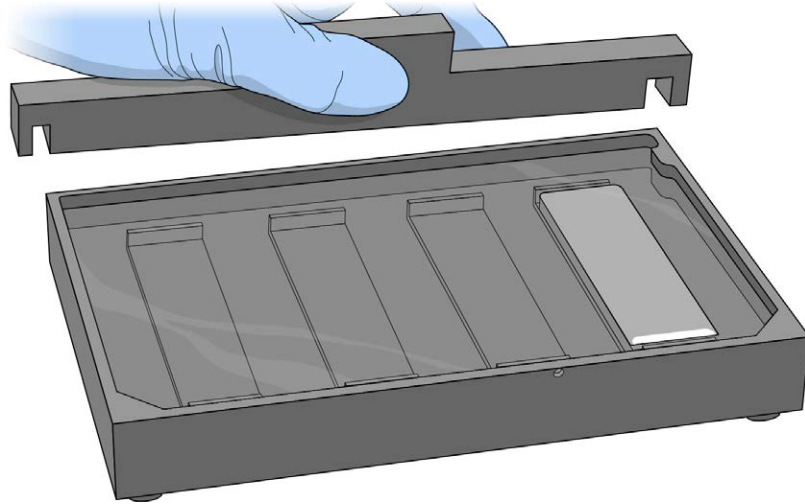

- Place a clean glass back plate on top of the clear spacer covering each BeadChip. The plate reservoir is at the barcode end of the BeadChip, facing inward to create a reservoir against the BeadChip surface.

Figure 56 Placing Glass Back Plate onto BeadChip

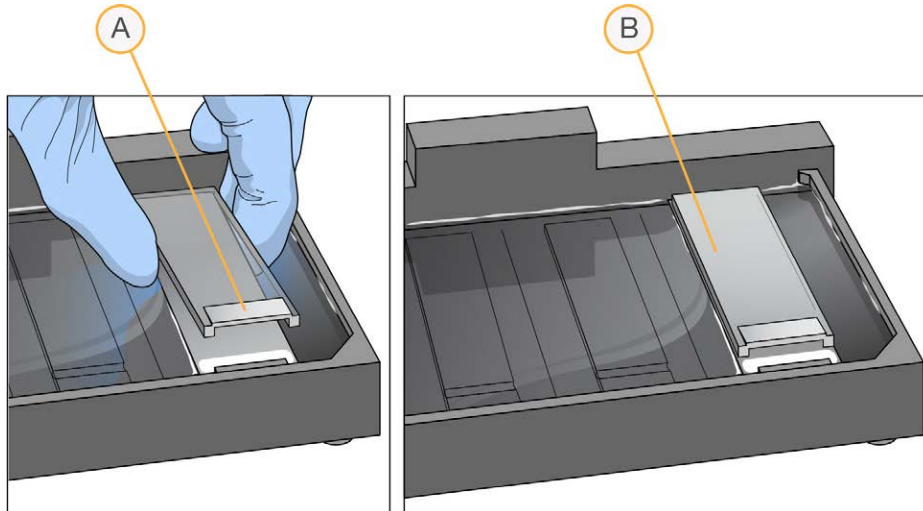

- A Reservoir at Barcode End of Glass Back Plate
 - B Glass Back Plate in Position
- 7 Attach the metal clamps to the flow-through chambers as follows:
- a Gently push the glass back plate against the alignment bar with one finger.
 - b Place the first metal clamp around the flow-through chamber so that the clamp is approximately 5 mm from the top edge.
 - c Place the second metal clamp around the flow-through chamber at the barcode end, approximately 5 mm from the reagent reservoir.

Figure 57 Securing Flow-Through Chamber Assembly with Metal Clamps

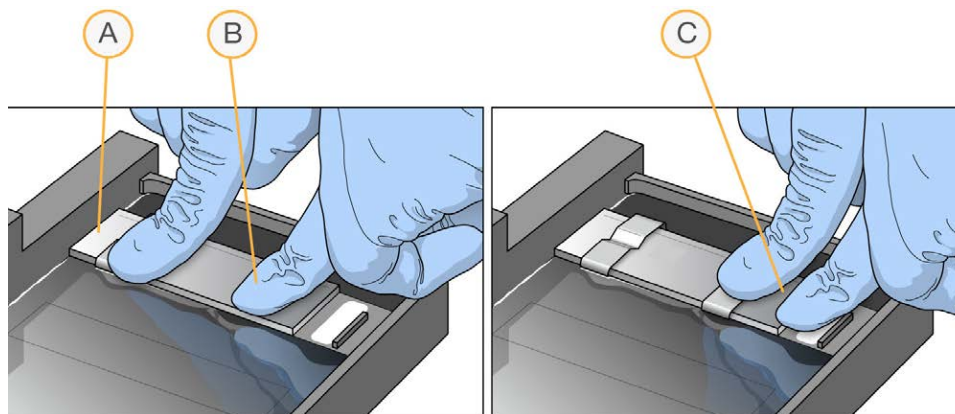

- A One Stripe Shows Between First Clamp and Alignment Bar
 - B Glass Back Plate Pressed Against Alignment Bar
 - C No Stripes Show Between Second Clamp and Barcode
- 8 Using scissors, trim the ends of the clear plastic spacers from the flow-through chamber assembly. Slip scissors up over the barcode to trim the other end.

Figure 58 Trimming Spacer Ends from Flow-Through Chamber Assembly

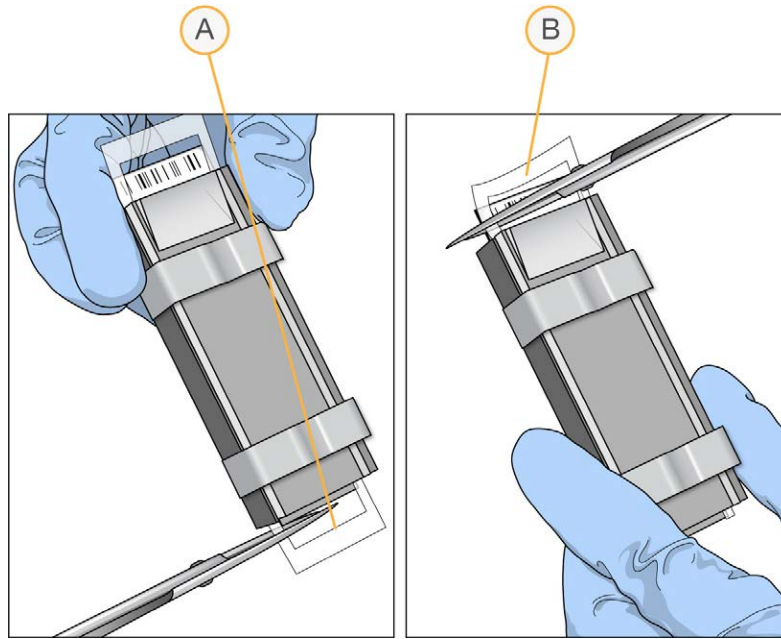

- A Trim Spacer at Non-Barcode End of Flow-Through Chamber
 B Trim Spacer at Barcode End of Flow-Through Chamber

- 9 **Immediately** wash the Hyb Chamber reservoirs with DiH_2O and scrub them with a small cleaning brush, ensuring that no PB2 remains in the Hyb Chamber reservoir.



CAUTION

It is important to wash the Hyb Chamber reservoirs immediately and thoroughly to make sure that no traces of PB2 remain in the wells.

- 10 Discard unused reagents in accordance with facility standards.
 11 Proceed to the next step, *Extend and Stain (XStain) BeadChip (Post-Amp)*.



CAUTION

Place all assembled flow-through chambers on the lab bench in a horizontal position while you perform the preparation steps for XStain BeadChip. Do not place the flow-through chambers in the chamber rack until all necessary steps are completed.

Extend and Stain (XStain) BeadChip (Post-Amp)

In this process, you use RA1 reagent to wash away unhybridized and nonspecifically hybridized DNA sample. Dispense TEM reagent into the flow-through chambers to extend the primers hybridized to DNA on the BeadChip. This reaction incorporates labeled nucleotides into the extended primers. 95% formamide/1 mM EDTA is added to remove the hybridized DNA. After neutralization using the XC3 reagent, the labeled extended primers undergo a multilayer staining process on the Chamber Rack. Next, you disassemble the flow-through chambers and wash the BeadChips in the PB1 reagent, coat them with XC4, and then dry them.

Figure 59 Extending and Staining BeadChip

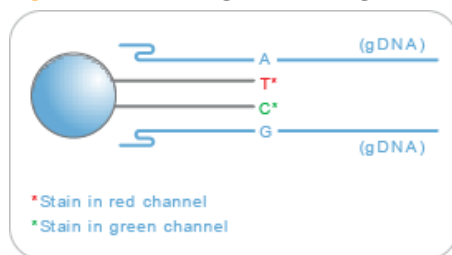

Estimated Time

Hands-on time: ~3 hours for 8 BeadChips

Dry time: 1 hour

Consumables

Item	Quantity (Per 8 BeadChips)	Storage	Supplied By
RA1	10 ml	-25°C to -15°C	Illumina
XC1	2 tubes	-25°C to -15°C	Illumina
XC2	2 tubes	-25°C to -15°C	Illumina

Item	Quantity (Per 8 BeadChips)	Storage	Supplied By
TEM	2 tubes	-25°C to -15°C	Illumina
XC3	75 ml	Room temperature	Illumina
STM (Make sure that all STM tubes indicate the same stain temperature on the label)	2 tubes	-25°C to -15°C	Illumina
ATM	2 tubes	-25°C to -15°C	Illumina
PB1	310 ml	Room temperature	Illumina
XC4	310 ml	-25°C to -15°C	Illumina
Alconox Powder Detergent	as needed		Illumina
EtOH	as needed	Room temperature	Illumina
95% formamide/1 mM EDTA	15 ml	-25°C to -15°C	User

**CAUTION**

Pour only the recommended reagent volume needed for the suggested number of samples listed in the Consumables table of each section. Some reagents are used later in the protocol.

**NOTE**

It is important to use fresh RA1 for each protocol step in the assay where it is required. RA1 that has been stored properly and has not been dispensed for use in either the XStain or Resuspension step is considered fresh RA1. After RA1 has been poured out into a reservoir and exposed to room temperature air for extended periods of time, it is no longer fresh.

**WARNING**

This protocol uses an aliphatic amide that is a probable reproductive toxin. Personal injury can occur through inhalation, ingestion, skin contact, and eye contact. For more information, consult the material data safety sheet for this assay at www.illumina.com/msds. Dispose of containers and any unused contents in accordance with the governmental safety standards for your region.

Preparation

- 1 RA1 is shipped and stored at -25°C to -15°C . Gradually warm the reagent to room temperature, preferably in a 20°C to 25°C water bath. Gently mix to dissolve any crystals that might be present.
- 2 Place all reagent tubes in a rack in the order in which they are used. If frozen, allow them to thaw to room temperature, and then gently invert the reagent tubes at least 10 times to mix contents.

Figure 60 XStain BeadChip Reagent Tubes and Bottles

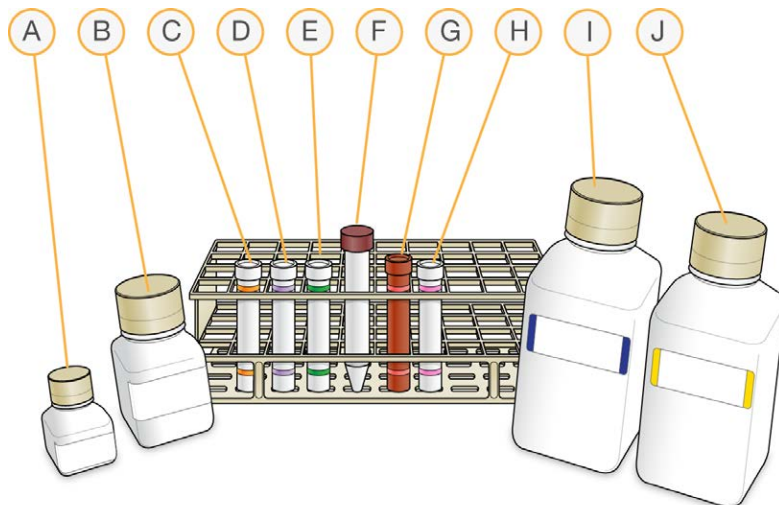

- A RA1
- B XC3
- C XC1
- D XC2
- E TEM

- F 95% Formamide / 1mM EDTA
- G STM
- H ATM
- I PB1
- J XC4

- 3 Make sure that the water circulator is filled to the appropriate level.
- 4 Turn on the water circulator. Set it to a temperature that brings the Chamber Rack to 44°C at equilibrium.
- 5 Remove bubbles trapped in the Chamber Rack.
- 6 Test several locations on the Chamber Rack, using the Illumina Temperature Probe. All locations should be at 44°C ± 0.5°C.
- 7 Dispense all bottled reagents into disposable reservoirs, as they are needed.
- 8 On the lab tracking form, record:
 - Date/Time
 - Operator
 - RA1 barcode
 - XC3 barcode
 - XC1 barcodes
 - XC2 barcodes
 - TEM barcodes
 - STM barcodes
 - ATM barcodes
 - PB1 barcode
 - XC4 barcodes

**NOTE**

To record information about your assay such as operator information, start and stop times, and barcodes, use the lab tracking form provided at www.illumina.com/documentation. This form can be filled out and saved online, or printed and filled in by hand.

Set Up Chamber Rack

- 1 Make sure that the water circulator reservoir is filled with water to the appropriate level. See the *VWR Operator Manual*, VWR part # 110-229.

- Turn on the water circulator and set it to a temperature that brings the chamber rack to 44°C at equilibrium.
This temperature can vary depending on facility ambient conditions.

Figure 61 Water Circulator Connected to Chamber Rack

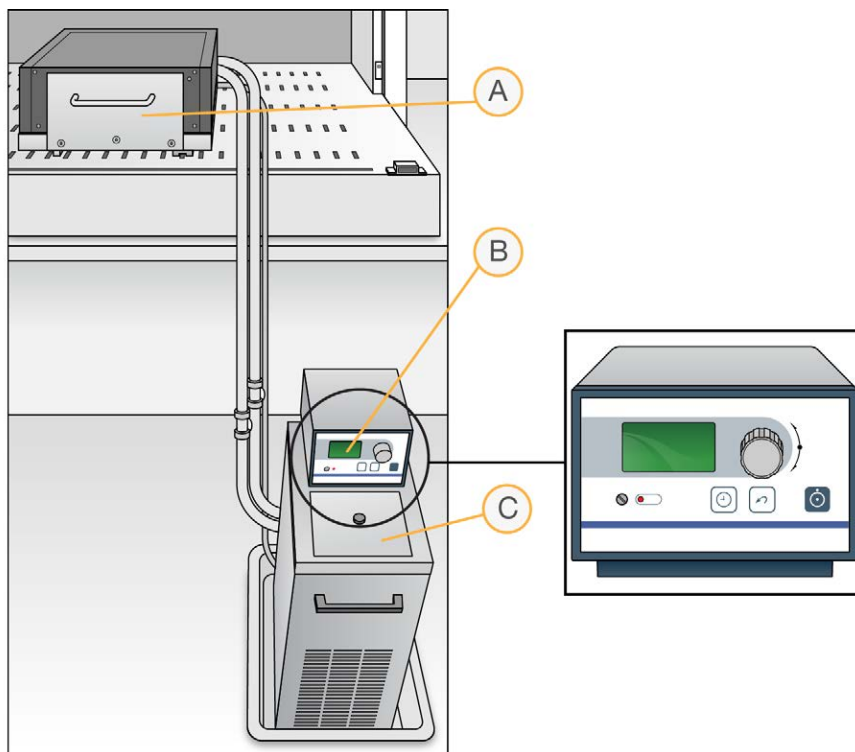

- A Chamber Rack
- B Water Circulator with Programmable Temperature Controls
- C Reservoir Cover

- Confirm the temperature using the temperature probe for the chamber rack. The temperature displayed on the water circulator LCD screen might differ from the actual temperature on the chamber rack.
- Make sure that you remove bubbles trapped in the chamber rack *each time* you run this process. Follow instructions in the *Te-Flow (Tecan Flow-Through Module) Operating Manual*, Tecan Doc ID 391584.

- 5 Use the Illumina Temperature Probe in several locations to make sure that the chamber rack is at 44°C. Make sure that all locations are at 44°C ± 0.5°C.



NOTE

Do not leave the temperature probe in the first 3 rows of the chamber rack. Reserve this space for BeadChips.

Figure 62 Illumina Temperature Probe and Temperature Probe in Chamber Rack

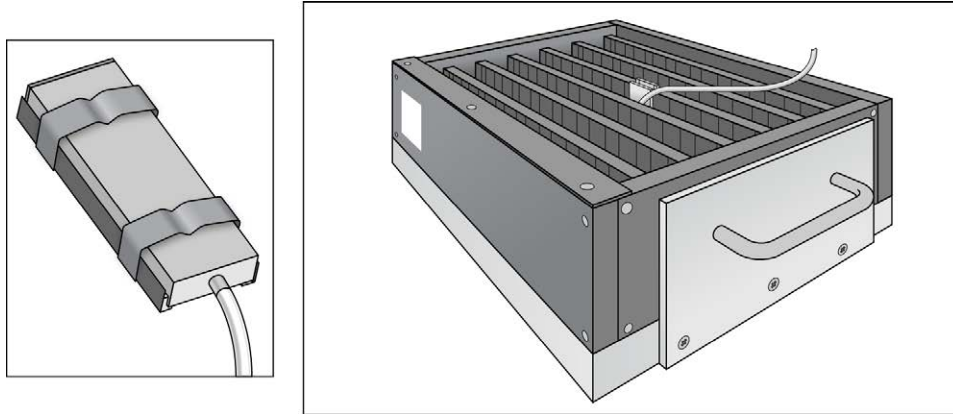

- 6 For accurate temperature measurement, make sure that the Illumina Temperature Probe is touching the base of the chamber rack.

Single-Base Extension



CAUTION

The remaining steps must be performed without interruption.

- 1 When the Chamber Rack reaches 44°C, quickly place each flow-through chamber assembly into the Chamber Rack.
For 4 BeadChips, place the flow-through chambers in every other position, starting at 1, in the first row of the Chamber Rack. For larger numbers of BeadChips, fill all positions in the first row, then the second and third.
- 2 Make sure that each flow-through chamber is properly seated on its rack to allow adequate heat exchange between the rack and the chamber.
- 3 On the lab tracking form, record the Chamber Rack position for each BeadChip.

- 4 Shake the XC4 bottle vigorously to ensure complete resuspension. If necessary, vortex until dissolved.

**CAUTION**

Do not allow pipette tips to contact BeadChip surface. Touch off in the reservoir of the glass back plate.

- 5 Into the reservoir of each flow-through chamber, dispense:
 - a 150 μ l RA1. Incubate for 30 seconds. Repeat for a total of 5 times.

Figure 63 Dispensing RA1 into Each Flow-Through Chamber

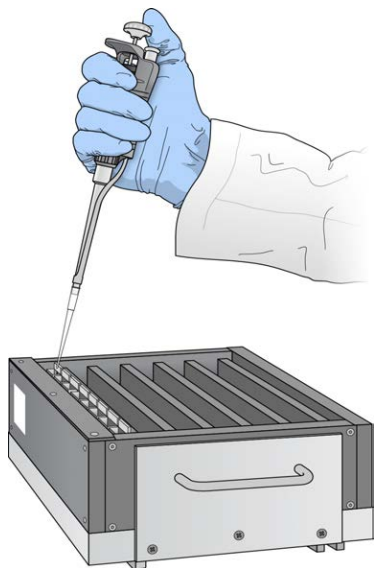
**CAUTION**

Pipette tip must not contact BeadChip surface.

- b 450 μ l XC1. Incubate for 10 minutes.
- c 450 μ l XC2. Incubate for 10 minutes.
- d 200 μ l TEM. Incubate for 15 minutes.
- e 450 μ l 95% formamide/1 mM EDTA. Incubate for 1 minute. Repeat one time.
- f Incubate 5 minutes.
- g Begin ramping the Chamber Rack temperature to the temperature indicated on the STM tube.

- h 450 μ l XC3. Incubate for 1 minute. Repeat one time.
- 6 Wait until the Chamber Rack reaches the correct temperature.

Stain BeadChip

- 1 If you plan to image the BeadChip immediately after the staining process, turn on the scanner now to allow the lasers to stabilize.
- 2 Into the reservoir of each flow-through chamber, dispense:
 - a 250 μ l STM. Incubate for 10 minutes.
 - b 450 μ l XC3. Incubate for 1 minute. Repeat one time.
 - c Wait 5 minutes.
 - d 250 μ l ATM. Incubate for 10 minutes.
 - e 450 μ l XC3. Incubate for 1 minute. Repeat one time.
 - f Wait 5 minutes.
 - g 250 μ l STM. Incubate for 10 minutes.
 - h 450 μ l XC3. Incubate for 1 minute. Repeat one time.
 - i Wait 5 minutes.
 - j 250 μ l ATM. Incubate for 10 minutes.
 - k 450 μ l XC3. Incubate for 1 minute. Repeat one time.
 - l Wait 5 minutes.
 - m 250 μ l STM. Incubate for 10 minutes.
 - n 450 μ l XC3. Incubate for 1 minute. Repeat one time.
 - o Wait 5 minutes.
- 3 Immediately remove the flow-through chambers from the Chamber Rack and place horizontally on a lab bench at room temperature.

Wash and Coat 8 BeadChips

Before starting the Wash and Coat process, read these important notes:

- ▶ Take the utmost care to minimize the chance of lint or dust entering the wash dishes, which could transfer to the BeadChips. Place wash dish covers on wash dishes when stored or not in use. Clean wash dishes with low-pressure air to remove particulates before use.

- ▶ In preparation for XC4 BeadChip coating, wash the tube racks and wash dishes thoroughly before and after use. Rinse with DI water. Immediately following wash, place racks and wash dishes upside down on a wash rack to dry.
- ▶ Place Kimwipes in 3 layers on the lab bench. Place a tube rack on top of these Kimwipe layers. Do not place on absorbent lab pads. You will place the staining rack containing BeadChips on this tube rack after removing it from the XC4 wash dish.
- ▶ Prepare an additional clean tube rack that fits the internal dimensions of vacuum desiccator for removal of the BeadChips. Allow one rack per 8 BeadChips. No Kimwipes are required under this tube rack.

Equipment Needed

Place the following items on the bench:

- ▶ 1 staining rack
- ▶ 1 vacuum desiccator
- ▶ 1 tube rack
- ▶ Self-locking tweezers
- ▶ Large Kimwipes
- ▶ Vacuum hose

Steps

- 1 Set up 2 top-loading wash dishes, labeled "PB1" and "XC4".
- 2 To indicate the fill volume before filling wash dishes with PB1 and XC4, pour 310 ml water into the wash dishes and mark the water level on the side. Empty the water from the wash dish. Marking the level enables you to pour reagent directly from the PB1 and XC4 bottles into the wash dishes, minimizing contaminant transfer from labware to wash dishes.

Figure 64 PB1 and XC4 Wash Dishes with Staining Rack

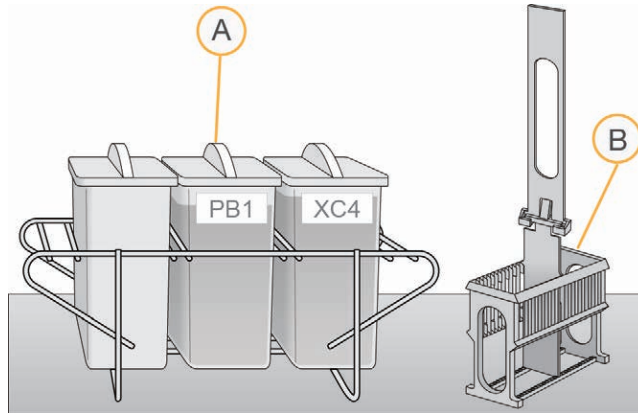

- A Wash Dishes
- B Staining Rack

- 3 Pour 310 ml PB1 into the wash dish labeled "PB1."
- 4 Submerge the unloaded staining rack into the wash dish with the locking arms and tab *facing towards* you. This orientation makes it easier and safer to remove the BeadChips. Let the staining rack sit in the wash dish. You will use it to carry the BeadChips after disassembling the flow-through chambers.

Figure 65 Staining Rack Locking Arms and Tab

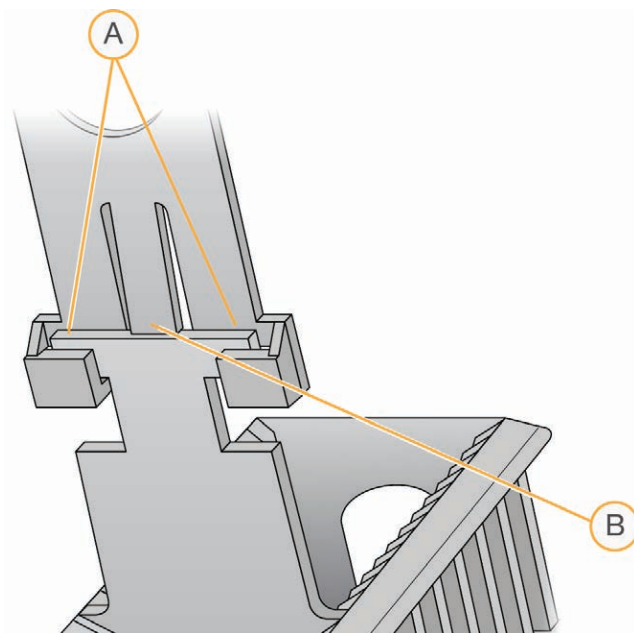

- A Locking Arms
- B Tab



CAUTION

If the staining rack handle is not correctly oriented, the BeadChips can be damaged when you remove the staining rack handle before removing the BeadChips.

- 5 One at a time, disassemble each flow-through chamber:
 - a Use the dismantling tool to remove the 2 metal clamps.



CAUTION

It is important to use the dismantling tool to avoid chipping the glass back plates.

Figure 66 Removing the Metal Clamps from Flow-Through Chamber

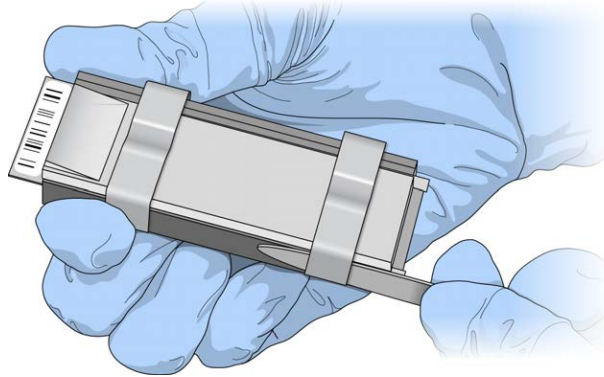

- b Remove the glass back plate.
- c Set the glass back plate aside. When you finish the XStain HD BeadChip protocol, clean the glass back plates as described in the *Infinium Lab Setup and Procedures Guide*.
- d Remove the spacer. To avoid damaging the stripes on the BeadChip, pull the spacer out so that the long sides slide along the sides of the BeadChip.
- e Remove the BeadChip.



CAUTION

Do not touch the face of the BeadChips. Handle them by the barcode end or by the edges.

- 6 Place the BeadChips in the staining rack while it is submerged in PB1. Put 4 BeadChips above the staining rack handle and 4 below the handle. Make sure that the BeadChip barcodes *face away* from you and that the locking arms on the handle *face towards* you.
If necessary, briefly lift the staining rack out of the wash dish to seat the BeadChip. Replace it immediately after inserting each BeadChip.
- 7 Make sure that the BeadChips are submerged.



CAUTION

Do not allow the BeadChips to dry. Submerge each BeadChip in the wash dish as soon as possible.

- 8 Slowly move the staining rack up and down 10 times, breaking the surface of the reagent.



NOTE

If the top edges of the BeadChips begin to touch during either PB1 or XC4 washes, gently move the staining rack back and forth to separate the slides. It is important for the solution to circulate freely between all BeadChips.

Figure 67 Washing BeadChips in PB1

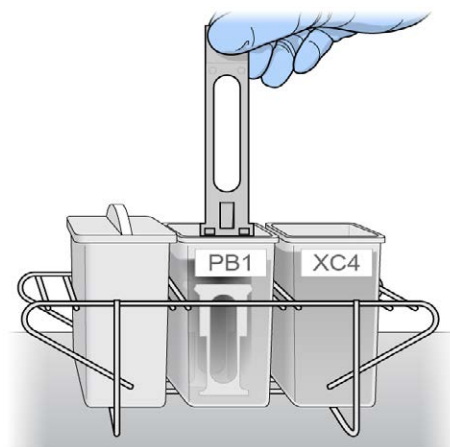

- 9 Allow the BeadChips to soak for an additional 5 minutes.



CAUTION

Do not leave the BeadChips in the PB1 for more than 30 minutes.

- 10 Shake the XC4 bottle vigorously to ensure complete resuspension. If necessary, vortex until dissolved.
- 11 Pour 310 ml XC4 into the dish labeled “XC4,” and cover the dish to prevent any lint or dust from falling into the solution.



CAUTION

Do not let the XC4 sit for longer than 10 minutes.

- 12 Remove the staining rack from the PB1 dish and place it directly into the wash dish containing XC4. For proper handling and coating, The barcode labels on the BeadChips must *face away* from you; the locking arms on the handle must *face towards* you.

Figure 68 Moving BeadChips from PB1 to XC4

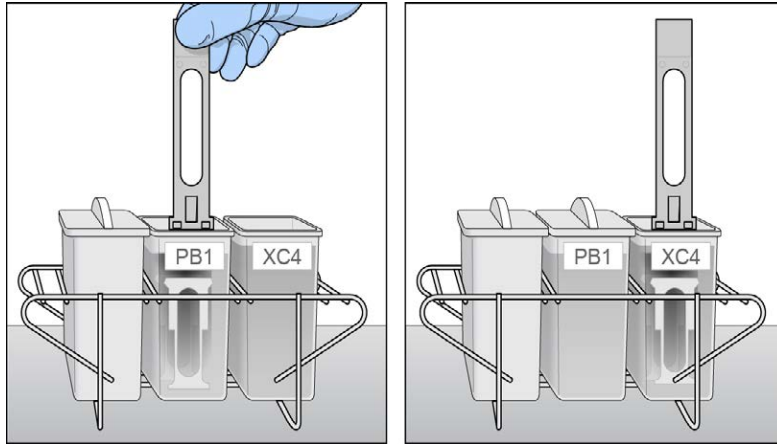

- 13 Slowly move the staining rack up and down 10 times, breaking the surface of the reagent.



NOTE

If the top edges of the BeadChips begin to touch during either PB1 or XC4 washes, gently move the staining rack back and forth to separate the slides. It is important for the solution to circulate freely between all BeadChips.

- 14 Allow the BeadChips to soak for an additional 5 minutes.



CAUTION

Use XC4 only one time. To process subsequent BeadChips, use a new, clean wash dish with fresh XC4.

- 15 Prepare 1 additional tube rack per 8 BeadChips (Illumina-provided from VWR catalog # 60916-748) that fits the internal dimensions of vacuum desiccator.
- 16 Remove the staining rack in one smooth, rapid motion and place it directly on the prepared tube rack, making sure that the barcodes *face up*, and the locking arms and tabs *face down*.

Figure 69 Staining Rack in Correct Orientation

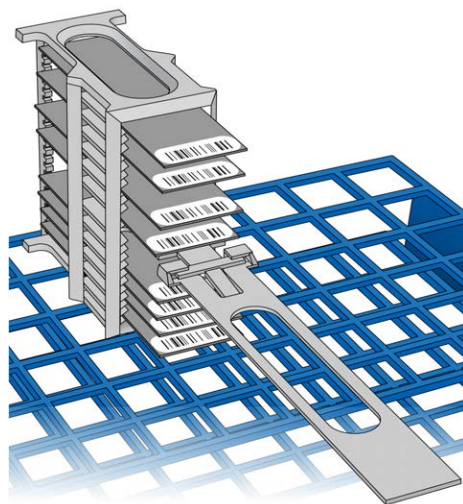

To ensure uniform coating, place the staining rack on the center of the tube rack, avoiding the raised edges.

Figure 70 Moving the Staining Rack from XC4 to Tube Rack

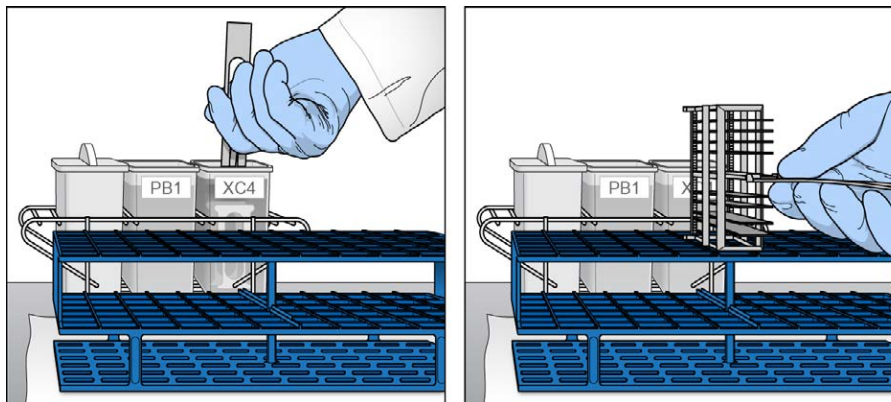

- 17 For each of the top 4 BeadChips, working top to bottom:

- a Continuing to hold the staining rack handle, carefully grip each BeadChip at its barcode end with self-locking tweezers.



NOTE

The XC4 coat is slippery and makes the BeadChips difficult to hold. The self-locking tweezers grip the BeadChip firmly and help prevent damage.

- b Place each BeadChip on a tube rack with the barcode *facing up and towards* you.

Figure 71 BeadChips on Tube Rack

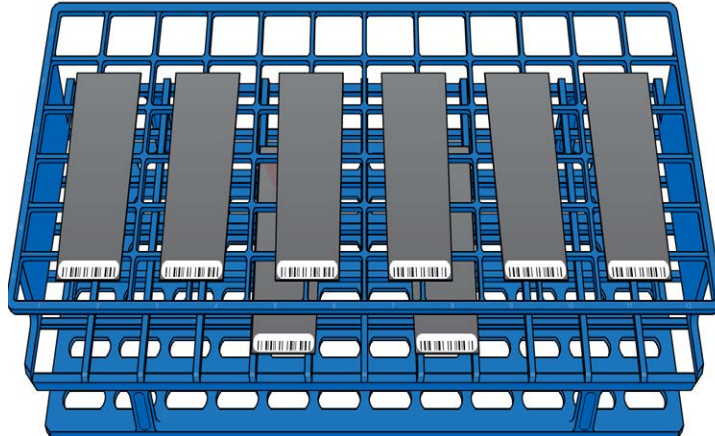

- 18 Holding the top of the staining rack in position, gently remove the staining rack handle by grasping the handle between the thumb and forefinger. Push up the tab with your thumb and push the handle away from you (unlocking the handle), then pull up the handle and remove.

Figure 72 Removing Staining Rack Handle

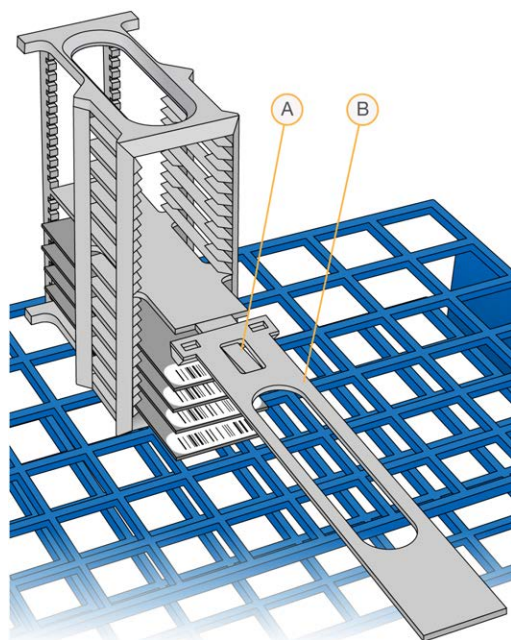

- A Tab
- B Handle

- 19 Remove the remaining BeadChips to the tube rack, with 6 BeadChips on top of the rack and 2 BeadChips on the bottom. Make sure that the barcode ends are towards you, and the BeadChips are completely horizontal.



CAUTION

To prevent wicking and uneven drying, do not allow the BeadChips to rest on the edge of the tube rack or to touch each other while drying.

- 20 Place the tube rack in the vacuum desiccator. Each desiccator can hold 1 tube rack (8 BeadChips).



CAUTION

Make sure that the vacuum valve is seated tightly and securely.

- 21 Remove the red plug from the three-way valve before applying vacuum pressure.
- 22 Start the vacuum, using at least 675 mm Hg (0.9 bar).

- 23 To make sure that the desiccator is properly sealed, gently lift the lid of the vacuum desiccator. It should not lift off the desiccator base.

Figure 73 Testing Vacuum Seal



- 24 Dry under vacuum for 50–55 minutes.
Drying times can vary according to room temperature and humidity.
- 25 Release the vacuum by turning the handle very slowly.



WARNING

Make sure that air enters the desiccator very slowly to avoid disturbing the contents. Improper use of the vacuum desiccator can result in damage to the BeadChips, especially if you remove the valve plug while a vacuum is applied. For detailed vacuum desiccator instructions, see the documentation included with the desiccator.

- 26 Store the desiccator with the red valve plug in the 3-way valve of the desiccator to stop accumulation of dust and lint within the valve port.
- 27 Touch the borders of the BeadChips (**do not touch the stripes**) to make sure that the etched, barcoded sides are dry to the touch.

- 28 If the underside feels tacky, manually clean the underside of the BeadChip to remove any excess XC4. The bottom 2 BeadChips are most likely to have some excess.
 - a Hold the BeadChip at a downward angle to prevent excess EtOH from dripping from the wipe onto the stripes.
 - b Wipe along the underside of the BeadChip 5 or 6 times, until the surface is clean and smooth.

**CAUTION**

Do *not* touch the stripes with the wipe or allow EtOH to drip onto the stripes.

- 29 Clean the glass back plates. For instructions, see the *Infinium Lab Setup and Procedures Guide*.
- 30 Discard unused reagents in accordance with facility standards.
- 31 Do either of the following:
 - Proceed to *Image BeadChip (Post-Amp)*.
 - Store the BeadChips in the Illumina BeadChip Slide Storage Box at room temperature. Image the BeadChips within 72 hours.

Image BeadChip (Post-Amp)

Follow the instructions in the *iScan System User Guide* or *HiScan System User Guide* to scan your BeadChips.

Use the **Methylation NXT** scan setting for your BeadChip.



NOTE

Follow the instructions in the *Decode File Client User Guide (11337856)* available on the Illumina support website to download your DMAPs.



NOTE

Use the *GenomeStudio Methylation Module v1.8 User Guide (11319130)* to analyze your data. Use the Infinium >> Infinium HD setting to create a GenomeStudio project for your BeadChip. Analysis requires a sample sheet that describes the location of each sample. See the support web page for your array for a sample sheet template.

Illumina GenomeStudio

Illumina GenomeStudio, an integrated data analysis software platform, provides a common environment for analyzing data obtained from microarray and sequencing technologies. Within this common environment, or framework, the Illumina GenomeStudio software modules allow you to perform application-specific analyses. The Illumina GenomeStudio Methylation Module, included with your Illumina Infinium Methylation Assay system, is an application for extracting genome-wide DNA methylation data from data files collected from systems such as the Illumina HiScan Reader. Experiment performance is based on built-in controls that accompany each experiment.

Data analysis features of the Illumina GenomeStudio Methylation Module include:

- ▶ Choice of assay analysis within a single application
- ▶ Data tables for information management and manipulation
- ▶ Plotting and graphing tools
- ▶ Whole-genome display of sample data in the IGV (Illumina Genome Viewer)
- ▶ Data visualization of one or more samples in the ICB (Illumina Chromosome Browser)
- ▶ Data normalization
- ▶ Custom report file formats
- ▶ Differential methylation analysis
- ▶ Assay-specific controls dashboards

For feature descriptions and instructions on using the Illumina GenomeStudio platform to visualize and analyze genome-wide DNA methylation data, see the *GenomeStudio Framework User Guide* and the *GenomeStudio Methylation Module User Guide*.

For technical assistance, contact Illumina Technical Support.

Automated Protocol

Introduction to Infinium HD Methylation Automated Protocol	106
Infinium HD Methylation Automated Workflow	107
Equipment, Materials, and Reagents	108
Quantify DNA [Optional] (Pre-Amp)	112
Make the BCD Plate (Pre-Amp)	122
Amplify DNA (Pre-Amp)	127
Incubate MSA4 Plate	136
Fragment DNA (Post-Amp)	138
Precipitate DNA (Post-Amp)	143
Resuspend DNA (Post-Amp)	151
Hybridize to BeadChips (Post-Amp)	156
Wash BeadChips (Post-Amp)	174
Extend and Stain (XStain) BeadChip (Post-AMP)	186
Image BeadChip (Post-Amp)	217
Illumina GenomeStudio	218



Introduction to Infinium HD Methylation Automated Protocol

This chapter describes pre- and post-amplification automated laboratory protocols for the Infinium HD Methylation Assay Protocol Guide. Follow the protocols in the order shown.

Before performing the protocols in this chapter, use the Zymo EZ DNA Methylation Kit to bisulfite convert the genomic DNA. For the automated Infinium Methylation assay, at least 1 μg of DNA is required. For instructions on how to bisulfite convert gDNA, see *Make the BCD Plate (Pre-Amp)* on page 122.

Some of the tasks in this chapter make reference to Illumina Laboratory Information Management System (LIMS). If you are performing the FFPE version of this assay or if you are not running Illumina LIMS, disregard those instructions. For information about how to use Illumina LIMS, see the Illumina LIMS User Guide.

Infinium HD Methylation Automated Workflow

The following figure graphically represents the Infinium HD Methylation Assay Protocol Guide automated workflow for 8 BeadChips. These protocols describe the procedure for preparing 96 DNA samples.

Figure 74 Infinium HD Methylation Assay Protocol Guide Automated Workflow

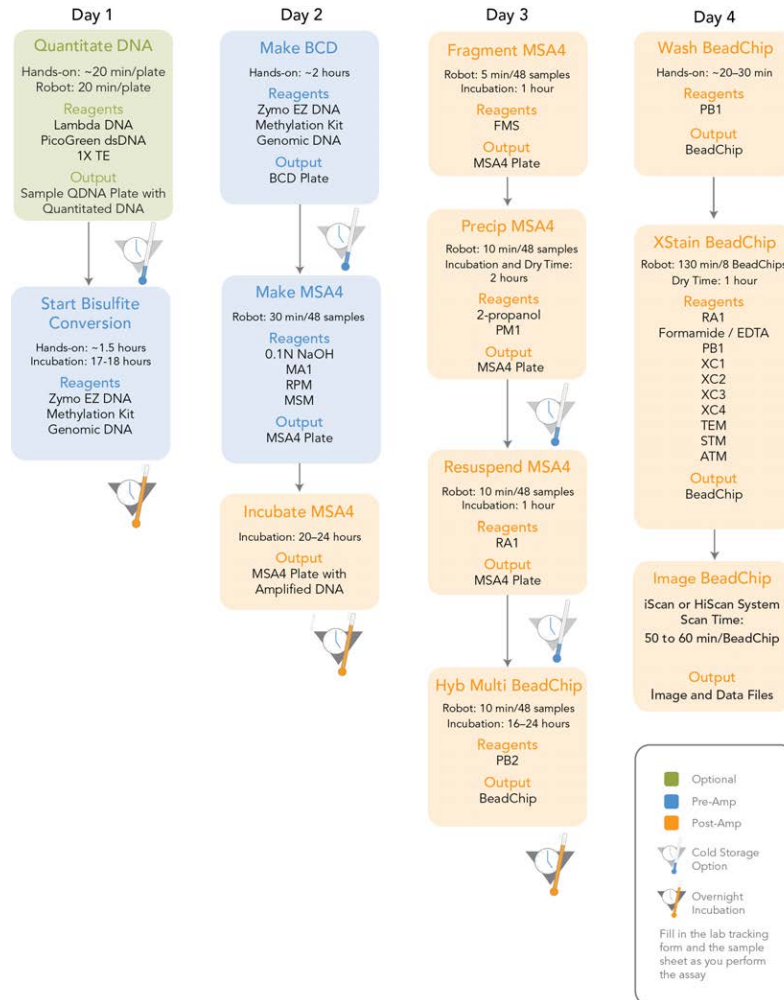

Equipment, Materials, and Reagents

These materials are required for the automated Infinium HD Assay for Methylation. For a list of other equipment, materials, and reagents needed in a lab performing Illumina Infinium assays, see the *Infinium Lab Setup and Procedures Guide*.

User-Supplied Equipment

Table 10 User-Supplied Equipment Infinium HD Methylation Assay, Automated Protocol

Item	Suggested Vendor
Vacuum desiccator (1 per 8 BeadChips processed simultaneously)	VWR, catalog # 24988-197
Vacuum tubing	VWR, catalog # 62995-335
2 Tecan 8-tip robots (1 for pre- and 1 for post-amplification processes)	Non-Illumina LIMS customers <ul style="list-style-type: none"> • SC-30-401 (110V) - North America and Japan • SC-30-402 (220V) - EU and Asia Pacific (Except Japan) Illumina LIMS customers <ul style="list-style-type: none"> • SC-30-403 (110V) - North America and Japan • SC-30-404 (220V) - EU and Asia Pacific (Except Japan)
Carboy > 10 L, 2 per robot, Pre-PCR	
Autodesiccator cabinet (Optional— Allows scanning of BeadChips up to 3 days after processing)	VWR, catalog # 74950-342

Illumina-Supplied Equipment

Table 11 Illumina-Supplied Materials Infinium HD Methylation Assay, Automated

Item	Catalog or Part #
Multi-Sample BeadChip alignment fixture	218528
Robot BeadChip Alignment Fixture (6)	222691
Robot Tip Alignment Guide-B inserts	11294913
Robot Tip Alignment Guide-B	Two-piece: catalog # SE-104-1002, Part# 11294201 One-piece: catalog # SE-104-1006, Part# 11323260

User-Supplied Materials

Table 12 User-Supplied Materials Infinium HD Methylation Assay, Automated Protocol

Item	Suggested Vendor
96-well, black, flat-bottom FLUOTRAC 200 plates	Greiner, catalog # 655076
Forceps	VWR, catalog # 25601-008
Aluminum foil	
Foil adhesive seals (Microseal "F")	MJ Research, catalog # MSF-1001
Reservoir, full, 150 ml	Beckman Coulter, catalog # 372784
Reservoir, half, 75 ml	Beckman Coulter, catalog # 372786
Reservoir, quarter, 40 ml	Beckman Coulter, catalog # 372790
Reservoir frames, 2 (1 per Tecan)	Beckman Coulter, catalog # 372795

Item	Suggested Vendor
Tube racks for vacuum desiccator (1 for every 8 BeadChips to be processed simultaneously; must fit internal dimensions of vacuum desiccator)	VWR, catalog # 66023-526
Vacuum source (greater than 508 mm Hg (0.68 bar))	
Vacuum gauge for vacuum desiccator (recommended)	

Illumina-Supplied Materials

- ▶ WG#-MSA4 barcode labels
- ▶ WG#-BCD barcode labels
- ▶ WG#-DNA barcode labels
- ▶ WG#-QNT barcode labels

Illumina-Supplied Reagents

Table 13 Illumina-Supplied Reagents Infinium HD Methylation Assay, Automated Protocol

Item	Part #
ATM —Anti-Stain Two-Color Master Mix	11208317
FMS —Fragmentation solution	11203428
MA1 —Multi-Sample Amplification 1 Mix	11202880
RPM —Random Primer Mix	15010230
MSM —Multi-Sample Amplification Master Mix	11203410
PB1 —Reagent used to prepare BeadChips for hybridization	11291245
PB2 —Humidifying buffer used during hybridization	11191130
PM1 —Precipitation solution	11292436

Item	Part #
RA1 —Resuspension, hybridization, and wash solution	11292441
STM —Superior Two-Color Master Mix	11288046
TEM —Two-Color Extension Master Mix	11208309
XC1 —XStain BeadChip solution 1	11208288
XC2 —XStain BeadChip solution 2	11208296
XC3 —XStain BeadChip solution 3	11208392
XC4 —XStain BeadChip solution 4	11208430

Quantify DNA [Optional] (Pre-Amp)

This process uses the PicoGreen dsDNA quantification reagent to quantify double-stranded DNA samples. You can quantify up to 3 plates, each containing up to 96 samples. If you already know the concentration, proceed to *Make the BCD Plate (Pre-Amp)* on page 122.

Illumina recommends the Molecular Probes PicoGreen assay to quantify dsDNA samples. The PicoGreen assay can quantify small DNA volumes, and measures DNA directly. Other techniques might pick up contamination such as RNA and proteins. Illumina recommends using a spectrofluorometer because fluorometry provides DNA-specific quantification. Spectrophotometry might also measure RNA and yield values that are too high.

Estimated Time

Hands-on time: ~20 minutes per plate

Robot: 20 minutes per plate

Consumables

Item	Quantity	Storage	Supplied By
PicoGreen dsDNA quantification reagent	See Instructions	-25°C to -15°C	User
1X TE (10 mM Tris-HCl pH8.0, 1 mM EDTA (TE))	See Instructions	Room temperature	User
Lambda DNA	See Instructions	2° to 8°C	User
96-well 0.65 ml microplate	1 per 96 samples		User
FLUOTRAC 200 96-well flat-bottom plate	1 per Std DNA plate 1 per Sample DNA plate		User



NOTE

PicoGreen is susceptible to differential contaminants. False positives might occur for whole-genome amplification. Therefore, it is important to quantify the input into the whole-genome amplification reaction.

Preparation

- ▶ Thaw PicoGreen to room temperature in a light-impermeable container.
- ▶ Follow the instructions for preparing the robot before each use in the *Infinium Lab Setup and Procedures Guide*.
- ▶ Thaw the sample DNA plates to room temperature.
- ▶ Apply a QDNA barcode label to a new FLUOTRAC plate for each GS#-DNA plate to be quantified.
- ▶ Hand-label the microplate “Standard DNA.”
- ▶ Hand-label a FLUOTRAC plate “Standard QDNA.”
- ▶ In the sample sheet, enter the Sample_Name (optional) and Sample_Plate for each Sample_Well.

Make a Standard DNA Plate

In this process, you create a Standard DNA plate with serial dilutions of stock Lambda DNA in the wells of column 1.

- 1 Add stock Lambda DNA to well A1 in the plate labeled “Standard DNA” and dilute it to 75 ng/μl in a final volume of 233.3 μl. Pipette up and down several times.
 - a Use the following formula to calculate the amount of stock Lambda DNA to add to A1:

$$\frac{(233.3 \mu\text{l}) \times (75 \text{ ng}/\mu\text{l})}{(\text{stock Lambda DNA concentration})} = \mu\text{l of stock Lambda DNA to add to A1}$$
 - b Dilute the stock DNA in well A1 using the following formula:

$$\mu\text{l of 1X TE to add to A1} = 233.3 \mu\text{l} - \mu\text{l of stock Lambda DNA in well A1}$$
- 2 Add 66.7 μl 1X TE to well B1.
- 3 Add 100 μl 1X TE to wells C, D, E, F, G, and H of column 1.

Figure 75 Dilution of Stock Lambda DNA Standard

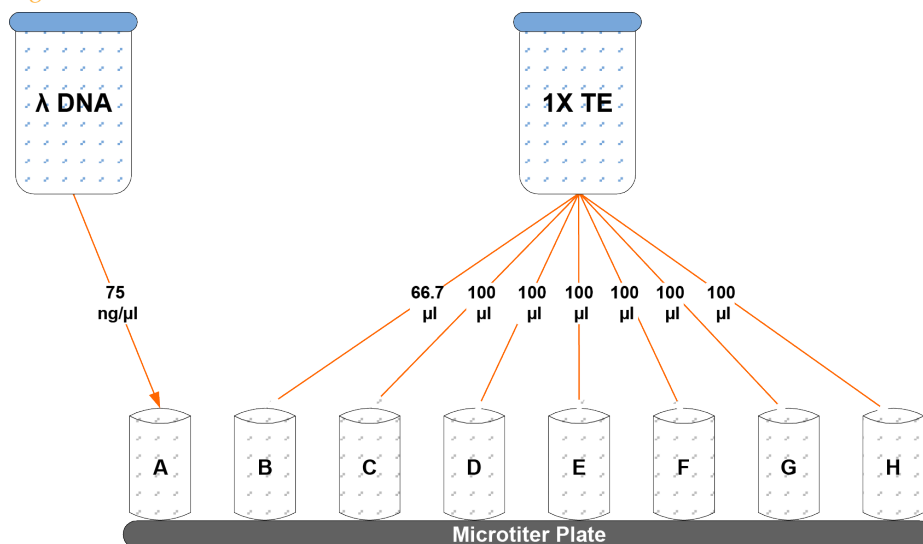

- 4 Transfer 133.3 μ l of Lambda DNA from well A1 into well B1. Pipette up and down several times.
- 5 Change tips. Transfer 100 μ l from well B1 into well C1. Pipette up and down several times.
- 6 Repeat for wells D1, E1, F1, and G1, changing tips each time. **Do not transfer from well G1 to H1.** Well H1 serves as the blank 0 ng/ μ l Lambda DNA.

Table 14 Concentrations of Lambda DNA

Row-Column	Concentration (ng/ μ l)	Final Volume in Well (μ l)
A1	75	100
B1	50	100
C1	25	100
D1	12.5	100

Row-Column	Concentration (ng/ μ l)	Final Volume in Well (μ l)
E1	6.25	100
F1	3.125	100
G1	1.5262	200
H1	0	100

Figure 76 Serial Dilutions of Lambda DNA

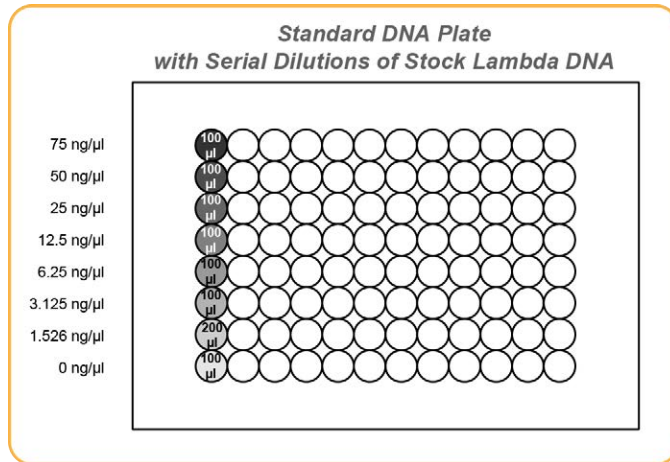

- Cover the Standard DNA plate with cap mat.

Dilute PicoGreen

The diluted PicoGreen is added to both the Standard QDNA and Sample QDNA plates to make the DNA fluoresce when read with the spectrofluorometer.



CAUTION

PicoGreen reagent degrades quickly in the presence of light. Also, do not use glass containers for PicoGreen reagent, because it adheres to glass, lowering its effective concentration in solution and effecting the upper response range accuracy.

- 1 Prepare a 1:200 dilution of PicoGreen into 1X TE using a sealed 100 ml or 250 ml Nalgene bottle wrapped in aluminum foil.

Refer to the following table to identify the volumes to produce diluted reagent for multiple 96-well QDNA plates. For fewer than 96 DNA samples, scale down the volumes.

Table 15 Volumes for PicoGreen Reagents

# QDNA Plates	PicoGreen Volume (μl)	1X TE Volume (ml)
1	115	23
2	215	43
3	315	63

- 2 Cap the foil-wrapped bottle and vortex to mix.

Create QDNA Standard and Sample Plates

In this process, PicoGreen is distributed to Standard QDNA and Sample QDNA FLUOTRAC plates and mixed with aliquots of DNA from the respective DNA plates.



CAUTION

Do not run any other programs or applications while using the Tecan robot. Your computer and the robot might lock up and stop a run.

- 1 At the robot PC, select **DNA Quant | Make Quant**.
- 2 In the DNA Plate Selection dialog box, select the plate type of the Standard DNA and Sample DNA plates (either midi, TCY, or ABGN plates). Roll the mouse pointer over each picture to see a description of the plate.

Figure 77 DNA Plate Selection Dialog Box



- In the Basic Run Parameters pane, enter the **Number of DNA/QDNA plates** (1, 2, or 3 pairs) and the **Number of DNA Samples**.
The robot PC updates the Required Run Items and the bed map to show the correct position of items on the robot bed. All barcodes must face to the right.

Figure 78 Make QDNA Screen

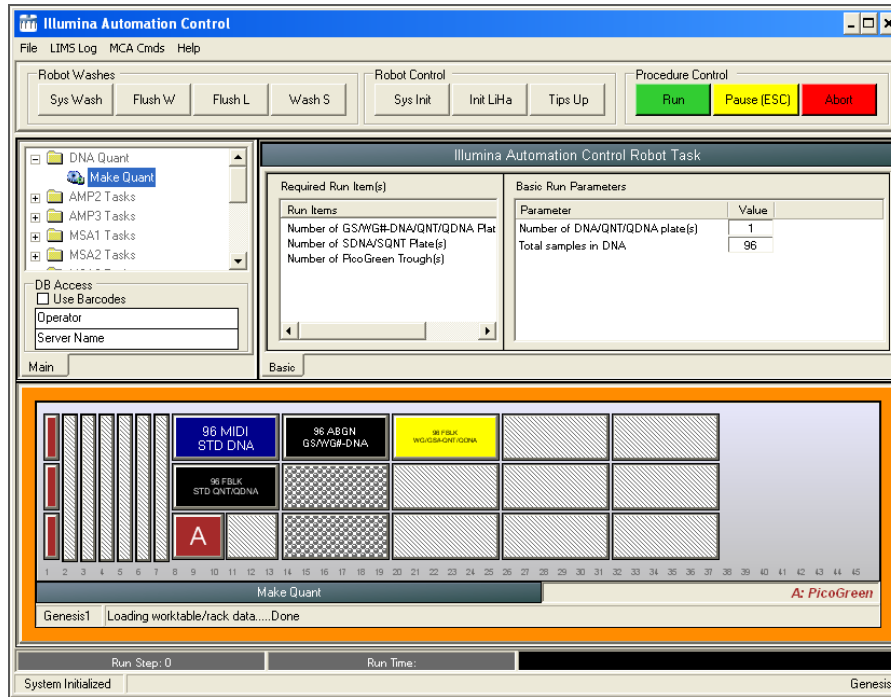

- Vortex the GS#-DNA Sample plate at 1450 rpm for 1 minute.
- Centrifuge the GS#-DNA Sample plate to $280 \times g$ for 1 minute.
- Vortex the Standard DNA plate at 1450 rpm for 1 minute.
- Centrifuge the Standard DNA plate at $280 \times g$ for 1 minute.
- Place the GS#-DNA Sample, Standard DNA, Standard QDNA, and QDNA Sample plates on the robot bed according to the robot bed map. Place well A1 at the top-left corner of its robot bed carrier. Remove any plate seals.
- Pour the PicoGreen dilution into half reservoir A and place it on the robot bed.

- 10 Make sure that all items are placed correctly on the robot bed, all caps and seals have been removed, and all barcodes face to the right.
- 11 On the lab tracking form, record the position of the plates on the robot bed.
- 12 Clear the **Use Barcodes** checkbox.
- 13 Click **Run**. Observe the beginning of the robot run to make sure that there are no problems.

The robot transfers 195 μ l of diluted PicoGreen to all FLUOTRAC plates, then transfers 2 μ l aliquots of DNA from the Standard DNA plate to the Standard QDNA plate and from the GS#-DNA plate to the sample QDNA plates.

The robot PC sounds an alert and opens a message when the process is complete.
- 14 Click **OK** in the message box.
- 15 On the lab tracking form, record:
 - Date/Time
 - Operator
 - Robot
 - The QDNA barcode that corresponds to each GS#-DNA barcode
 - The Standard QDNA plate that corresponds to each Standard DNA plate
- 16 After the robot finishes, immediately seal all plates:
 - a Place foil adhesive seals over Sample QDNA and Standard QDNA plates.
 - b Place cap mats on GS#-DNA Sample and Standard DNA plates.
- 17 Discard unused reagents in accordance with facility requirements.
- 18 Store the GS#-DNA and Standard DNA plates at 2° to 8°C or -25°C to -15°C.
- 19 Centrifuge the Sample QDNA Plate and Standard QDNA plates to 280 \times g for 1 minute.

Read the QDNA Plate

In this process, you use the Gemini XS or XPS spectrofluorometer with the Illumina Fluorometry Analysis software to read the Standard QDNA and Sample QDNA plates. You use the software to create a standard curve based on the quantities of Standard DNA with PicoGreen. Then you read the Sample QDNA plates to compare their data against the standard curve to obtain the concentration of sample DNA. For the best performance, Illumina recommends a minimum concentration of 50 ng/ μ l.

- 1 Turn on the spectrofluorometer.
- 2 At the PC, open the Illumina Fluorometry Analysis program.

Figure 79 Illumina Fluorometry Analysis Main Screen

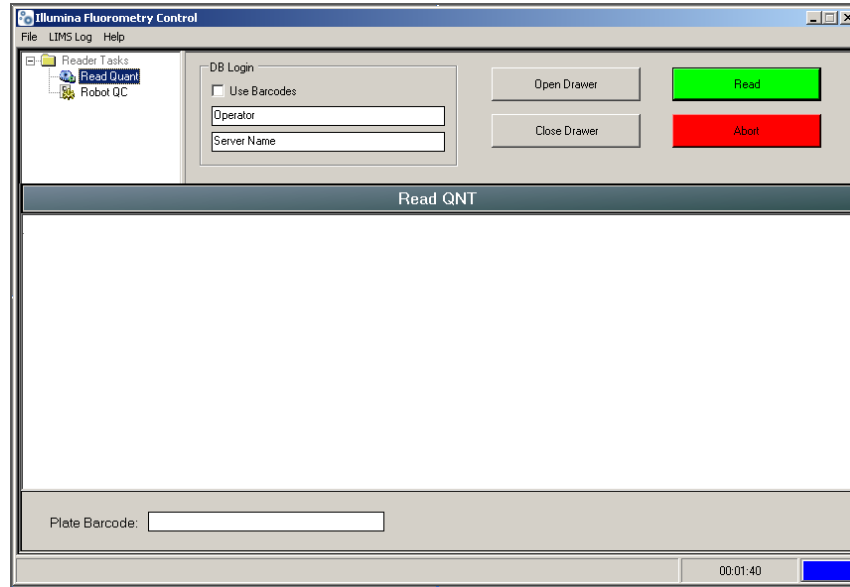

- 3 Select **Reader Tasks | Read Quant**.
- 4 (Non-Illumina LIMS) Clear the **Use Barcodes** checkbox.
- 5 (Illumina LIMS) Make sure that the **Use Barcodes** checkbox is checked.
- 6 Click **Read**.
- 7 (Illumina LIMS) When prompted, log in to the Illumina LIMS database.
- 8 When asked if you want to read a new Standard plate, click **Yes**.
- 9 Remove the plate seal and load the Standard QDNA plate into the fluorometry tray. Click **OK**. The spectrofluorometer reads the plate data.
- 10 Review the data from the Standard QDNA plate. Either accept it and go on to the next step, or reject it. Rejecting the data stops the Read Quant process.
- 11 Remove the Standard QDNA plate from the spectrofluorometer tray.

- 12 When prompted, enter the number of plates you want to read (1, 2, or 3). Do not include the Standard QDNA plate in this number. Click **OK**.
- 13 When prompted, hand-scan the Sample QDNA plate barcode. Click **OK**.
- 14 When prompted, remove the plate seal from the Sample QDNA plate and load it into the spectrofluorometer tray, with well A1 at the upper left corner. Click **OK**. The spectrofluorometer reads the plate data.
- 15 Remove the Standard QDNA plate from the spectrofluorometer tray.
- 16 When prompted, click **Yes** to review the raw Sample QDNA plate data.

Figure 80 Sample QDNA Data

The screenshot shows the 'Illumina Fluorometry Control' software window. The 'Read QNT' section displays a table of fluorescence intensity values for 8 rows (A-H) and 12 columns (01-12). The status bar at the bottom indicates 'Successfully completed procedure: Read Quant - Elapsed run time: 00:04:08'.

Read QNT												
Index	01	02	03	04	05	06	07	08	09	10	11	12
A	109.986	97.386	86.639	87.972	37.740	58.986	59.564	105.795	58.045	65.290	111.854	112.313
B	53.762	64.782	81.328	71.074	44.373	85.217	74.908	41.362	30.936	81.944	42.114	97.331
C	78.122	77.755	48.808	56.321	73.823	57.230	52.543	52.354	29.819	59.105	99.113	95.701
D	78.078	78.275	77.324	84.341	1.836	61.958	91.516	28.879	111.245	46.436	108.011	130.246
E	31.923	56.506	74.072	69.935	49.999	71.742	39.596	90.452	58.236	26.842	71.746	125.311
F	65.631	72.087	100.190	82.523	92.392	25.795	50.323	12.566	61.255	57.128	107.547	142.955
G	62.332	54.109	90.108	72.893	47.027	56.525	49.487	62.623	35.501	55.730	132.712	148.758
H	98.662	55.846	58.381	95.563	98.032	69.188	59.364	81.855	33.680	92.185	56.394	52.237

- 17 Microsoft Excel opens automatically at the same time and displays the quantification data for the Sample QDNA plate. There are 3 tabs in the file:
 - **SQDNA_STD**—Generates the standard curve by plotting the Relative Fluorescence (RF) values measured in the Standard QDNA plate against assumed concentrations in the Standard DNA Plate.
 - **QDNA**—Plots the concentration (ng/ μ l) of each well of the Sample QDNA Plate as derived from the standard curve.

- **Data**—A readout of the raw data values for the Standard QDNA plate and the Sample QDNA Plate.
- 18 The Illumina Fluorometry Analysis software prompts you to indicate whether you wish to save the QDNA data shown in an Excel file. Select the option you prefer:
 - Click **Yes** to save.
(Illumina LIMS) The data are sent to Illumina LIMS. In Illumina LIMS, the QDNA plate moves into the *Make Single-Use DNA (SUD) Plate (Pre-PCR)* queue.
 - Click **No** to delete the quant data. You can read the same plate for quant data repeatedly.
 - 19 If you entered more than one Sample QDNA plate to read, repeat steps 13 to 16 for each additional plate.
 - 20 Discard the QDNA plates and reagents in accordance with facility requirements.
 - 21 Do either of the following:
 - Proceed to *Make BCD Plate (Pre-Amp)*.
 - Store the Sample QDNA plate at 2°C to 8°C for up to 1 month.

Make the BCD Plate (Pre-Amp)

This process uses the Zymo EZ DNA Methylation Kit to convert unmethylated cytosines (C) in genomic DNA to uracil (U), though leaving methylated cytosines (C) unchanged for methylation analysis.

Figure 81 Bisulfite Conversion

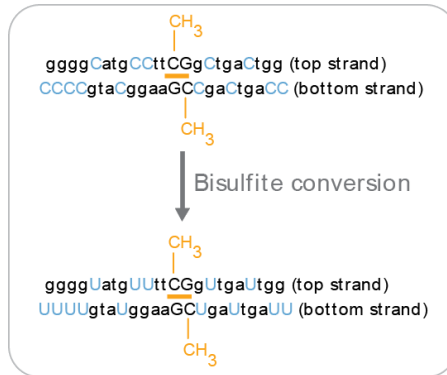

Methylation detection in bisulfite-converted DNA (BCD) is based on the different sensitivity of cytosine and 5-methylcytosine to deamination by bisulfite. Under acidic conditions, cytosine undergoes conversion to uracil, though methylated cytosine remains unreactive. An effective bisulfite conversion protocol is a prerequisite for a successful Infinium HD Assay for Methylation. Incomplete conversion of cytosine to uracil can result in false-positive methylation signals, and can reduce the overall quality of the assay data.



NOTE

Always perform bisulfite conversion of DNA in the pre-amp area.

Figure 82 Bisulfite Conversion Workflow

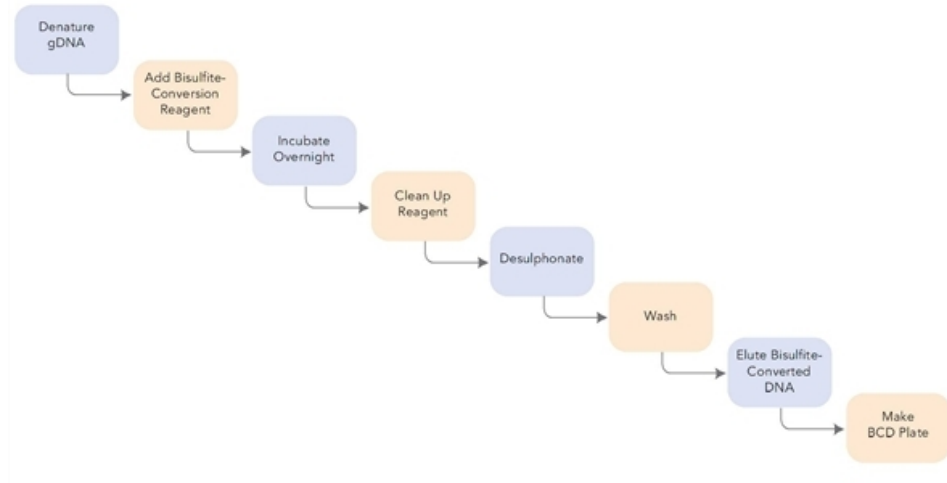

Bisulfite convert the genomic DNA samples using the Zymo EZ DNA Methylation Kit. Transfer the bisulfite-converted samples to the BCD plate.

Estimated Time

Hands-on time:

- ~1.5 hours on Day 1
- ~2 hours on Day 2

Incubation time: 16–17 hours on Day 1 (Overnight)

Consumables

Item	Quantity	Storage	Supplied By
Zymo EZ DNA Methylation kit (includes bisulfite conversion reagent, dilution buffer, desulphonation buffer, elution buffer)	1 kit per 50 samples 1 kit per 200 samples or 1 kit per 2 plates	Room temperature	User

Item	Quantity	Storage	Supplied By
96-well 0.2 ml skirted microplate	1–3 plates		User
Genomic DNA (for HD Methylation)	≥ 250 ng for each bisulfite conversion reaction ≥1000 ng for each bisulfite conversion reaction		User
FFPE DNA (for HD FFPE Methylation)	≥250 ng for each bisulfite conversion reaction for manual or automated process		

Illumina recommends using the Zymo Research EZ DNA methylation kit for bisulfite conversion of genomic DNA. Follow Illumina recommended incubation conditions during bisulfite conversion to maximize DNA conversion rate.

For all other steps, follow the instructions from the manufacturer for use, because the protocols vary significantly for different kits.



CAUTION

Bisulfite conversion kits that are not specified in this guide are not supported for use with the Infinium HD Methylation Assay Protocol Guide.



NOTE

Illumina supports down to 250 ng fresh DNA for this reaction. When possible, using more DNA, such as 500 ng or 1000 ng, results in higher reproducibility.

Preparation

Use this table to determine the correct amount of genomic DNA for each bisulfite conversion process.

Table 16 Genomic DNA Input for Bisulfite Conversion

	Amount of gDNA	Elution Buffer	Number of Activation Reactions Supported
Manual process	> 500 ng	12 μ l	Enough for 2 replicates
Automated process	1000 ng	22 μ l	Enough for 2 replicates

- ▶ Prepare the conversion reagent according to the instructions from the manufacturer. For best results, use it immediately.

**CAUTION**

The conversion reagent is photosensitive, so minimize its exposure to light.

- ▶ Prepare the wash buffer according to the manufacturer instructions.
- ▶ Apply a BCD barcode label to each new 96-well 0.2 ml skirted microplate.
- ▶ On the Lab Tracking Form, record the following:
 - Date and time
 - Operator

**NOTE**

To record information about your assay such as operator information, start and stop times, and barcodes, use the lab tracking form provided at www.illumina.com/documentation. This form can be filled out and saved online, or printed and filled in by hand.

Steps to Make the BCD Plate

Day 1

The following steps are intended only to provide an overview of the process. For specific instructions, use the manufacturer documentation.

- 1 Follow the instructions in the Zymo EZ DNA Methylation Kit to denature the genomic DNA and add conversion reagent.
- 2 Incubate in a thermal cycler using the following conditions for 16 cycles:
 - 95°C for 30 seconds
 - 50°C for 1 hour

**NOTE**

Denaturation is necessary for bisulfite conversion because the conversion reagent only works on single-stranded DNA.

- 3 Hold DNA at 4°C for 10 minutes in the thermal cycler until you are ready to do the clean-up.

Day 2

- 1 Follow the instructions in the Zymo EZ DNA Methylation Kit to do the following:

- a Clean the samples using the provided spin columns or filter plate. Wash off the remaining conversion reagent.

**NOTE**

When using the Zymo EZ DNA Methylation Kit, centrifuge the plate to between 3000 and 5000 × g for optimal performance.

- b Desulphonate the column or plate with desulphonation buffer. Incubate at room temperature for 15 minutes.
- c Clean the samples and wash twice to remove the desulphonation buffer.
- d Add elution buffer:
 - 12 µl for manual process from 500 ng gDNA
 - 22 µl for automated process from 1 µg of gDNA
- e Centrifuge to elute.

**NOTE**

When using the Zymo EZ DNA Methylation Kit, centrifuge the plate to between 3000 and 5000 × g for 5 minutes for optimal performance.

- 2 Transfer the bisulfite-converted DNA (BCD) samples to the BCD plate.
- 3 On the lab tracking form, record the WG#-BCD and BCD plate barcodes.
- 4 Heat-seal the plate and store it at -25°C to -15°C. Thaw the plate completely and vortex to mix contents before using it in an assay.

**CAUTION**

Do not store BCD for more than one month at -25°C to -15°C.

**SAFESTOPPINGPOINT**

Now is a good stopping point in the process.

Amplify DNA (Pre-Amp)

This process creates an MSA4 plate for BCD amplification. MA1 is first added to the MSA4 plate, followed by the BCD samples. 0.1N NaOH is added to denature the BCD samples. The RPM reagent neutralizes the sample. Multi-Sample Amplification Master Mix (MSM) is then added to the BCD samples.

Figure 83 Denaturing and Neutralizing BCD

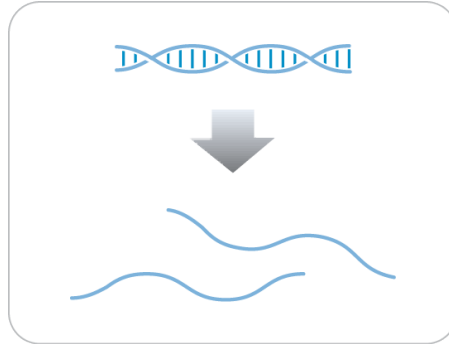

Estimated Time

Robot time:

- 30 minutes for 48 samples
- 45 minutes for 96 samples

Consumables

Item	Quantity	Storage	Supplied By
MA1	2 tubes (per 96 samples)	Room temperature	Illumina
RPM	2 tubes (per 96 samples)	-25°C to -15°C	Illumina

Item	Quantity	Storage	Supplied By
MSM	2 tubes (per 96 samples)	-25°C to -15°C	Illumina
0.1N NaOH	15 ml (per 96 samples)	2°C to 8°C	User
96-well 0.8 ml microplate (MIDI)	1 plate		User
BCD plate with Bisulfite- converted DNA samples	1 plate	-25°C to -15°C	User

**NOTE**

Thaw all reagents completely at room temperature and allow to equilibrate. After thawed, gently invert each tube several times to mix the reagent thoroughly. Pulse centrifuge each tube to $280 \times g$ to eliminate bubbles and collect reagent at the bottom of the tube.

Preparation

- 1 In preparation for the Incubate DNA process, preheat the Illumina Hybridization Oven in the post-amp area to 37°C and allow the temperature to equilibrate.
- 2 In the sample sheet, enter the Sample_Name and Sample_Plate for each Sample_Well.
- 3 Apply an MSA4 barcode label to a new MIDI.
- 4 Thaw MA1, RPM, and MSM tubes to room temperature.
- 5 Thaw BCD samples to room temperature.
 - ▶ On the Lab Tracking Form, record the following:
 - Date/Time
 - Operator
 - Robot
 - Batch number
 - Number of samples (48 or 96)
 - BCD plate barcodes
 - MSA4 plate barcodes
 - MA1 tube barcodes

- RPM tube barcodes
- MSM tube barcodes



NOTE

To record information about your assay such as operator information, start and stop times, and barcodes, use the lab tracking form provided at www.illumina.com/documentation. This form can be filled out and saved online, or printed and filled in by hand.

Prepare Robot

For instructions on preparing the robot for use in a protocol, see the *Infinium Assay Lab Setup and Procedures Guide*.

Refer to the following figure throughout this protocol. All the barcodes face to the right.

Figure 84 Tecan 8-Tip Robot (Make MSA4 Setup)

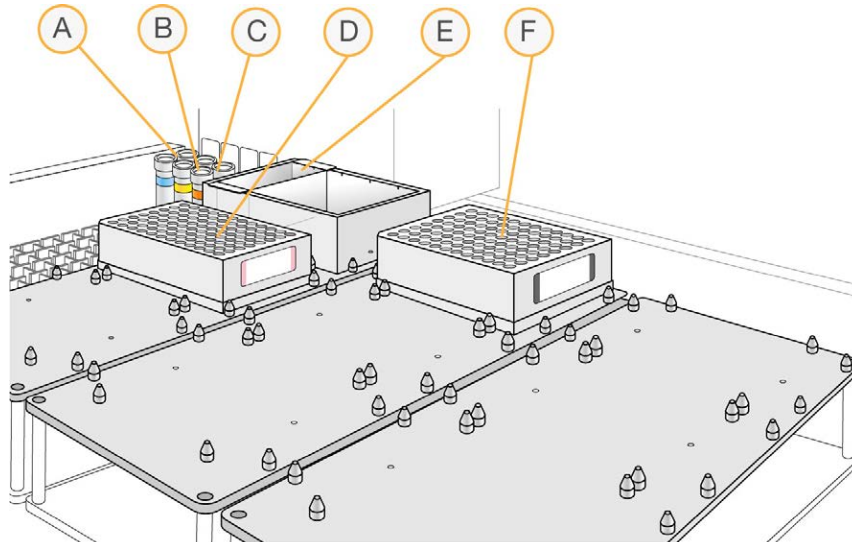

- A MA1 Tube
- B RPM Tube
- C MSM Tube
- D MSA4 Plate
- E NaOH in Quarter Reservoir
- F BCD Plate (TCY or MIDI)

Steps to Make the MSA4 Plate

- 1 If you do not already have a WG#-BCD plate, add BCD into either of the following:
 - Midi plate: 20 μ l to each WG#-BCD plate well
 - TCY plate: 10 μ l to each WG#-BCD plate well
 Apply a barcode label to the new WG#-BCD plate.
- 2 At the robot PC, select **MSA4 Tasks | Make MSA4**.
- 3 In the Plate Selection dialog box, click the plate type you wish to use. Roll the mouse pointer over each picture to see a description of the plate.

Figure 85 Selecting the Plate Type



NOTE

Do not mix plate types on the robot bed.

- 4 (Non-Illumina LIMS) Make sure that the **Use Barcodes** checkbox is cleared. In the Basic Run Parameters pane, enter the **Number of DNA samples** (48 or 96) that are in the plate. This value must match the number of DNAs in the plate and the number of DNAs identified in the DNA manifest.



NOTE

If you are using Illumina LIMS, you cannot change the number of DNA samples on this screen. However, the Illumina LIMS software processes the correct number of samples.

You can process up to 96 DNA samples per robot run.

The robot PC updates the Required Run Items and the bed map to show the correct position of items on the robot bed. All barcodes must face to the right.



NOTE

If you are using Illumina LIMS, you must click **Run** and select batches before the robot bed map displays the correct layout for the WG#-BCD plates.

Figure 86 Make MSA4 Screen

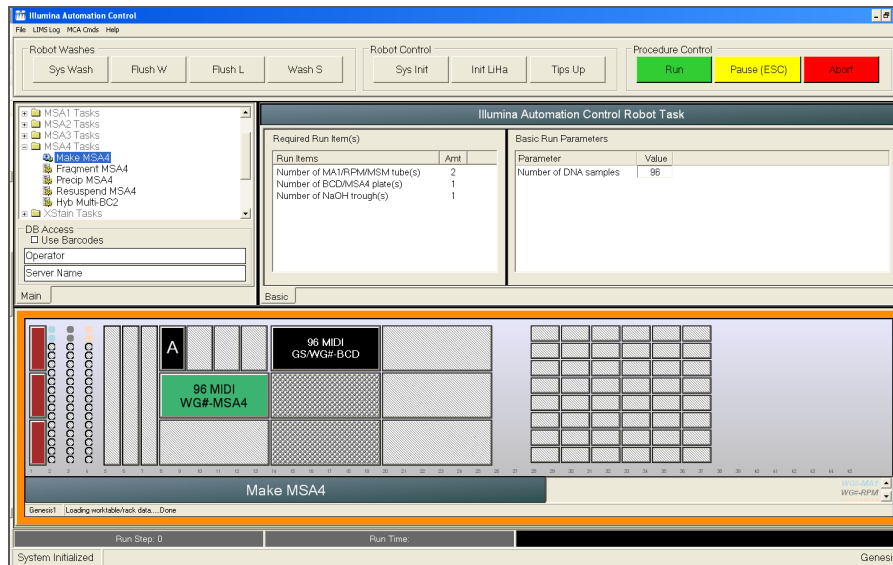

- 5 Remove caps from MA1, RPM, and MSM tubes, then place the tubes in the robot standoff tube rack according to the bed map.
- 6 Add 15 ml 0.1 N NaOH to the quarter reservoir, then place the reservoir on the robot bed according to the bed map.
- 7 Place the WG#-BCD and MSA4 plates on the robot bed according to the bed map.
- 8 In the Lab Tracking Form, record the plate positions on the robot bed.
- 9 Make sure that all items are placed properly on the robot bed, all caps and seals have been removed, and all the barcodes face to the right.
- 10 (Non-Illumina LIMS) At the robot PC, click **Run**.
- 11 (Illumina LIMS) At the robot PC:
 - a Make sure that the **Use Barcodes** checkbox is cleared.
 - b Click **Run** to start the process. Log in if prompted.
 After the robot initializes, the **Make MSA4** screen appears.

Figure 87 Selecting Project Batch for MakeMSA4

The screenshot shows a dialog box titled "Make MSA4" with a blue header bar. The dialog is divided into two main vertical panes. The left pane is titled "Project Name:" and contains a list of project names: "LASI_Test_Itai_Human610Quad1_11.29.10", "SWA_Itai_HumanMethylation450v1", "082510_48samples_TestLIMS", "Methylation", "Methylation2", and "Methylation1". Below this list are two search fields: "Search By:" with a dropdown arrow and "Search For:" with a text input field. There are "Search" and "Reset" buttons below the search fields. The right pane is titled "Sample Batch ID (double click batch number to add):" and contains a large empty text box. Below this is a section titled "Plate(s):" with another large empty text box. At the bottom of the right pane is a section titled "Selected Batches:" with a large empty text box and a "Remove" button. At the very bottom of the dialog are "OK" and "Cancel" buttons.

- 12 (Illumina LIMS) Do either of the following:
 - Select your current project. The available batches appear in the Sample Batch ID pane. Select a batch to see the associated DNA plate appear in the DNA Plates pane.

Figure 88 Make MSA4 Screen with Project and Batch Selected

- Use the **Search** box to search for a specific Batch ID or DNA Plate.
- 13 (Illumina LIMS) Select the batch you want to run, and then click **OK**.
 - 14 (Illumina LIMS) Click **OK** to confirm the required DNAs.

Figure 89 Confirm DNAs

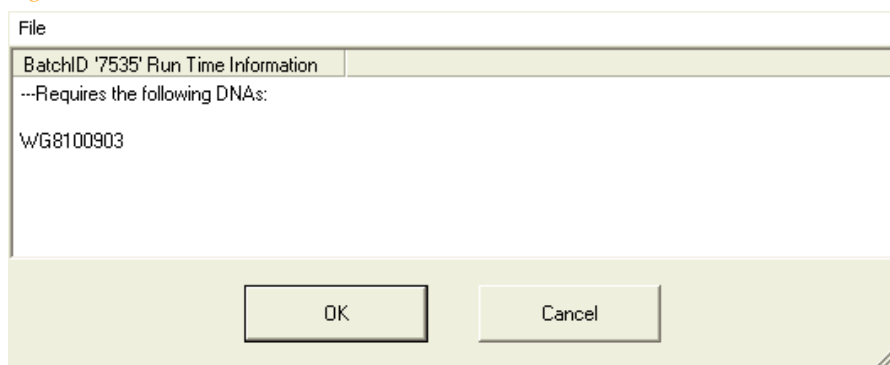

- 15 When prompted, enter the barcode of each WG#-BCD plate. The robot bed map is updated with the WG#-BCD plate locations.
- 16 Place the WG#-BCD plates on the robot bed according to the bed map and click OK. The robot begins running when the plates are in place.
- 17 Observe the robot run to make sure that there are no problems.
After the robot adds the 0.1N NaOH to the DNA in the MSA4 plate, follow the instructions at the prompt.
- 18 Seal the plate with a cap mat.
- 19 Vortex the sealed MSA4 plate at 1600 rpm for 1 minute.
- 20 Centrifuge at $280 \times g$ at 22°C for 1 minute.
- 21 Remove the cap mat.



NOTE
When you remove a cap mat, set it aside, upside down, in a safe location for use later in the protocol. When you place the cap mat back on the plate, be sure to match it to its original plate and orient it correctly.
- 22 Place the MSA4 plate back on the robot bed in its original position, and then click **OK**. The Wait for reaction time message appears. The wait time for this reaction is 10 minutes.
The robot PC sounds an alert and opens a message when the process is complete.
- 23 Click **OK** in the message box.
- 24 Remove the MSA4 plate from the robot bed and seal with the 96-well cap mat.

- 25 Invert the sealed MSA4 plate at least 10 times to mix contents.
- 26 Centrifuge at $280 \times g$ for 1 minute.
- 27 Discard unused reagents in accordance with facility standards.
- 28 Proceed immediately to the next step.

Incubate MSA4 Plate

This process incubates the MSA4 plate for 20–24 hours at 37°C in the Illumina Hybridization Oven. It generates a sufficient quantity of each individual DNA sample to be used twice in the Infinium HD Assay for Methylation.

Figure 90 Incubating DNA to Amplify

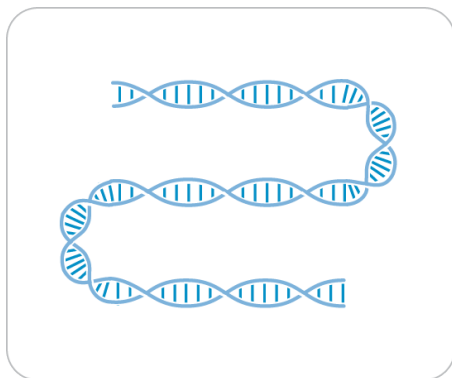

Estimated Incubation Time

20–24 hours

Verify MSA4 for Incubation (Illumina LIMS Only)

- 1 In the Illumina LIMS left pane, click **Infinium HD Methylation | Incubate MSA4**.
- 2 Scan the barcode of the MSA4 plate, click **Verify**, and then click **Save**.
- 3 If the MSA4 plate is queued for incubation, a blue confirmation message appears at the top of the window. Proceed to *Steps to Incubate the MSA4 Plate*.
- 4 If the MSA4 plate is not queued for incubation, a red error message appears at the top of the window. Do **not** proceed with incubation. Instead, follow these steps to troubleshoot the problem:
 - a Click the Reports tab in the upper-right corner.
 - b In the left pane, click **Tracking Reports | Get Queue Status**.
 - c Scan the plate barcode and click **Go**.

- d Note what step the plate is queued for, and proceed with that step.

For information about how to use Illumina LIMS, see the *Illumina LIMS User Guide*.

Steps to Incubate MSA4 Plate



OVERNIGHT INCUBATION

Incubate MSA4 plate in the Illumina Hybridization Oven for at least 20 hours but no more than 24 hours at 37°C.

- 1 Record the start and stop times on the lab tracking form.



NOTE

To record information about your assay such as operator information, start and stop times, and barcodes, use the lab tracking form provided at www.illumina.com/documentation. This form can be filled out and saved online, or printed and filled in by hand.

- 2 Proceed to the next step.

Fragment DNA (Post-Amp)

This process enzymatically fragments the amplified DNA samples. An endpoint fragmentation is used to prevent overfragmentation.

Figure 91 Fragmenting DNA



Estimated Time

Robot time:

- 5 minutes for 48 samples
- 10 minutes for 96 samples

Incubation time: 1 hour

Consumables

Item	Quantity	Storage	Supplied By
FMS	2 tubes (per 96 samples)	-25°C to -15°C	Illumina



NOTE

Thaw all reagents completely at room temperature and allow to equilibrate. After thawed, gently invert each tube several times to mix the reagent thoroughly. Pulse centrifuge each tube to $280 \times g$ to eliminate bubbles and collect reagent at the bottom of the tube.

Preparation

- 1 Preheat the heat block with the midi plate insert to 37°C.
- 2 Thaw FMS tubes to room temperature. Gently invert at least 10 times to mix contents.
- 3 Remove the MSA4 plate from the Illumina Hybridization Oven.
- 4 If you plan to Resuspend the MSA4 plate today, remove the RA1 from the freezer to thaw.
 - ▶ On the lab tracking form, record:
 - Date/Time
 - Operator
 - Robot
 - FMS tube barcodes



NOTE

To record information about your assay such as operator information, start and stop times, and barcodes, use the lab tracking form provided at www.illumina.com/documentation. This form can be filled out and saved online, or printed and filled in by hand.

Prepare Robot

For instructions on preparing the robot for use in a protocol, see the *Infinium Assay Lab Setup and Procedures Guide*.



CAUTION

Do not run any other programs or applications while using the Tecan robot. Your computer and the robot might lock up and stop a run.

Refer to the following figure throughout this protocol.

Figure 92 Tecan 8-Tip Robot (Fragment MSA4 Setup)

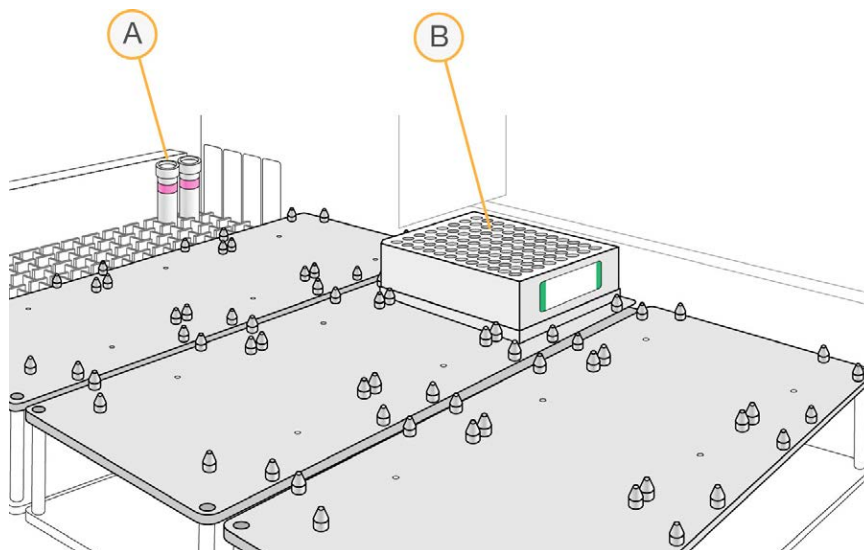

- A FMS tubes
- B MSA4 plate

Steps to Fragment the MSA4 Plate

- 1 Pulse centrifuge the MSA4 plate at $280 \times g$.
- 2 Remove the cap mat.
- 3 At the robot PC, select **MSA4 Tasks | Fragment MSA4**.

- (Non-Illumina LIMS) Make sure that the **Use Barcodes** checkbox is cleared. In the **Basic Run Parameters** pane, change the value for **Number of MSA4 plates** and **Number of DNA samples per plate** to indicate the number of samples being processed.



NOTE

If you are using Illumina LIMS, you cannot change the number of DNA samples on this screen. However, the LIMS software processes the correct number of samples.

The robot PC updates the Required Run Items and the bed map to show the correct position of items on the robot bed. All barcodes must face to the right.

Figure 93 Fragment MSA4 Screen

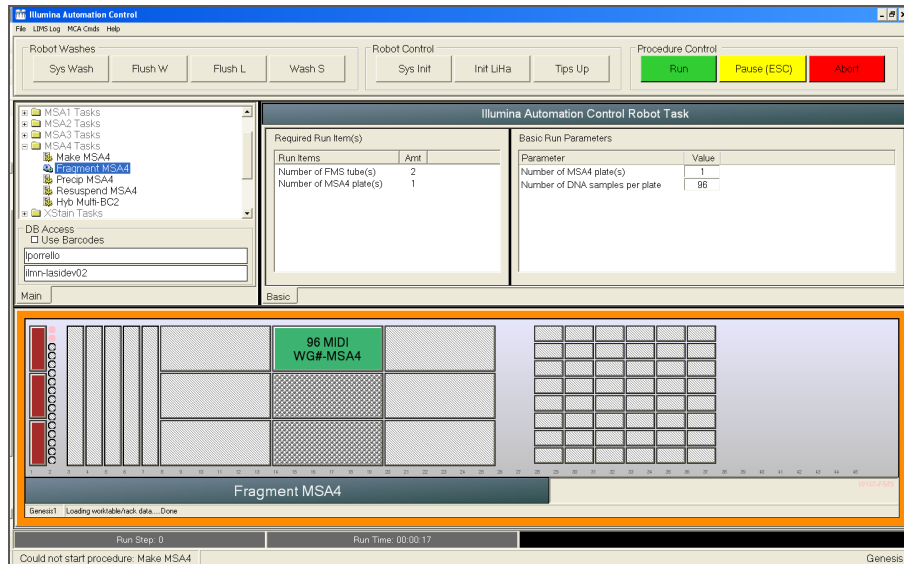

- Place the MSA4 plate on the robot bed according to the bed map.
- Place FMS tubes in the robot tube rack according to the bed map. Remove the cap.
- On the lab tracking form, record the plate positions on the robot bed.

Start the Robot

- (Non-Illumina LIMS) At the robot PC, click **Run**.

- 2 (Illumina LIMS) At the robot PC:
 - a Make sure that the **Use Barcodes** checkbox is selected.
 - b Click **Run** to start the process. Log in if prompted.The robot PC sounds an alert and displays a message when the process is done.
- 3 When the robot finishes, click **OK** in the message box.
- 4 Remove the MSA4 plate from the robot bed and seal it with a cap mat.
- 5 Vortex at 1600 rpm for 1 minute.
- 6 Pulse centrifuge at $280 \times g$.
- 7 Place the sealed plate on the 37°C heat block for 1 hour.
- 8 Record the start and stop times on the lab tracking form.
- 9 Discard unused reagents in accordance with facility standards.
- 10 Do either of the following:
 - Proceed to *Precipitate DNA (Post-Amp)*. Leave plate in 37°C heat block until you have completed the preparatory steps. Do not leave the plate in the 37°C heat block for longer than 2 hours.
 - If you do not plan to proceed to the next step within the next 4 hours, store the sealed MSA4 plate at -25°C to -15°C for more than 24 hours.

**SAFESTOPPING POINT**

Now is a good stopping point in the process.

Precipitate DNA (Post-Amp)

PM1 and 2-propanol are added to the MSA4 plate to precipitate the DNA samples.

Figure 94 Precipitating DNA

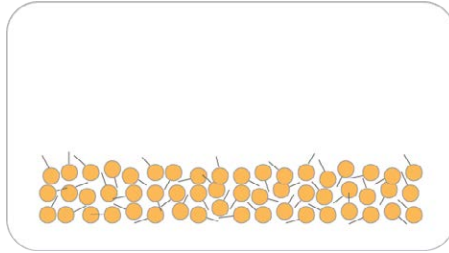

Estimated Time

Robot time:

- 10 minutes for 48 samples
- 15 minutes for 96 samples

Incubation and dry time: 2 hours

Consumables

Item	Quantity	Storage	Supplied By
PM1	2 tubes (per 96 samples)	2°C to 8°C	Illumina
100% 2-propanol	40 ml (per 96 samples)	Room temperature	User



NOTE

Thaw all reagents completely at room temperature and allow to equilibrate. After thawed, gently invert each tube several times to mix the reagent thoroughly. Pulse centrifuge each tube to $280 \times g$ to eliminate bubbles and collect reagent at the bottom of the tube.

Preparation

- 1 Preheat the heat block to 37°C.
- 2 If you froze the MSA4 plate overnight, thaw it to room temperature, then pulse centrifuge at 280 × g.
- 3 Thaw PM1 to room temperature. Gently invert at least 10 times to mix contents.
 - ▶ On the lab tracking form, record:
 - Date/Time
 - Operator
 - Robot
 - PM1 tube barcodes
 - 2-propanol lot number and date opened



NOTE

To record information about your assay such as operator information, start and stop times, and barcodes, use the lab tracking form provided at www.illumina.com/documentation. This form can be filled out and saved online, or printed and filled in by hand.

Prepare Robot

For instructions on preparing the robot for use in a protocol, see the *Infinium Assay Lab Setup and Procedures Guide*.

Refer to the following figure throughout this protocol. Barcodes face to the right.

Figure 95 Tecan 8-Tip Robot (Precip MSA4 Setup)

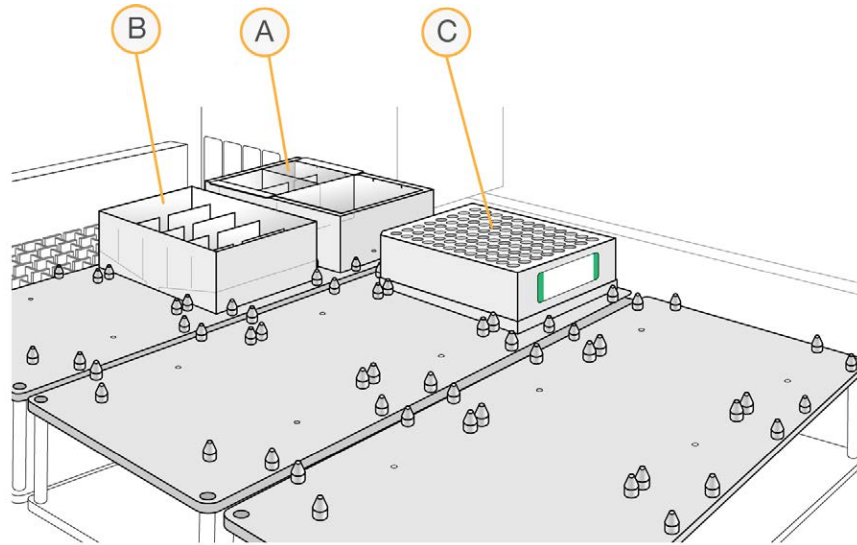

- A PM1 in Half Reservoir
- B 2-propanol in full Reservoir
- C MSA4 Plate

Steps to Precipitate the MSA4 Plate

- 1 At the robot PC, select **MSA4 Tasks | Precip MSA4**.
- 2 (Non-Illumina LIMS) Make sure that the **Use Barcodes** checkbox is cleared. In the **Basic Run Parameters** pane, change the value for **Number of MSA4 plates** and **Number of DNA samples per plate** to indicate the number of samples being processed.



NOTE

If you are using Illumina LIMS, you cannot change the number of DNA samples on this screen. However, the LIMS software processes the correct number of samples.

The robot PC updates the Required Run Items and the bed map to show the correct position of items on the robot bed. All barcodes must face to the right.

Figure 96 Precip MSA4 Screen

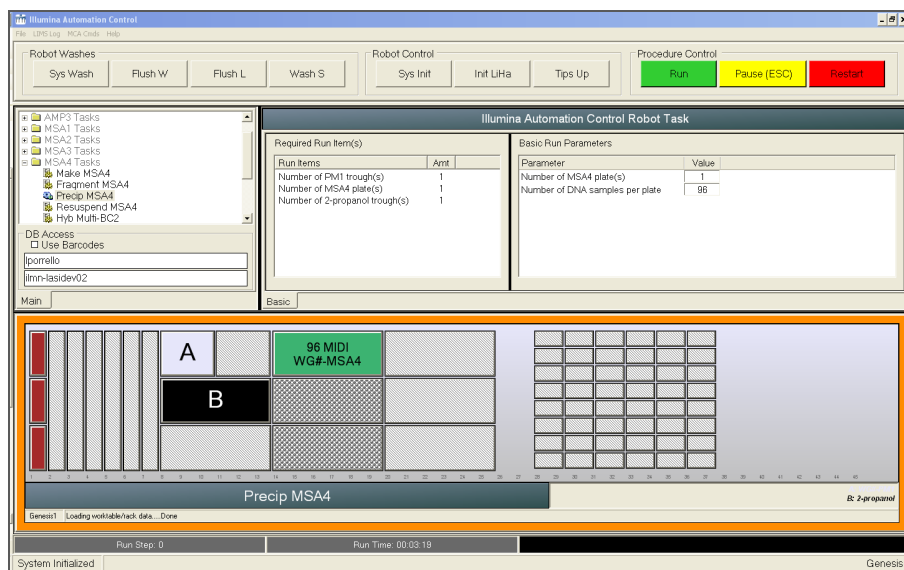

- 3 Pulse centrifuge the sealed MSA4 plate at $280 \times g$.
- 4 Remove the cap mat and place the MSA4 plate on the robot bed according to the bed map.
- 5 Place a half reservoir in the reservoir frame, according to the robot bed map, and add PM1 as follows:
 - For 48 samples: 1 tube PM1
 - For 96 samples: 2 tubes PM1
- 6 Place a full reservoir in the reservoir frame, according to the robot bed map, and add 2-propanol as follows:
 - For 48 samples, dispense 20 ml 2-propanol
 - For 96 samples, dispense 40 ml 2-propanol
- 7 In the lab tracking form, record the plate positions on the robot bed.
- 8 Make sure that all items are placed properly on the robot bed, all caps and seals have been removed, and all the barcodes face to the right.

Start the Robot

- 1 (Non-Illumina LIMS) At the robot PC, click **Run**.
- 2 (Illumina LIMS) At the robot PC:
 - a Make sure that the **Use Barcodes** checkbox is selected.
 - b Click **Run** to start the process. Log in if prompted.
The robot PC sounds an alert and opens a message when the process is complete.
- 3 When prompted, remove the MSA4 plate from the robot bed. Do not click **OK** in the message box yet.
- 4 Seal the MSA4 plate with the same cap mat removed earlier.
- 5 Vortex the sealed plate at 1600 rpm for 1 minute.
- 6 Incubate at 37°C for 5 minutes.
- 7 Pulse centrifuge at 280 × g.
 **NOTE**
Set the centrifuge to 4°C in preparation for the next centrifuge step.
- 8 Remove the cap mat and discard it.
- 9 Place the MSA4 plate back on the robot bed according to the bed map.
- 10 Click **OK** in the message box.
The robot PC sounds an alert and opens a message when the process is complete.
- 11 Click **OK** in the message box. Remove the MSA4 plate from the robot bed and carefully seal with a *new, dry* cap mat, taking care not to shake the plate in any way until the cap mat is fully seated.
- 12 Invert the plate at least 10 times to mix contents thoroughly.
- 13 Incubate at 4°C for 30 minutes.
- 14 Place the sealed MSA4 plate in the centrifuge opposite another plate of equal weight.

Figure 97 Sealed MSA4 Plate and Plate of Equal Balance in Centrifuge



- 15 Centrifuge at $3000 \times g$ at 4°C for 20 minutes. Immediately remove the MSA4 plate from centrifuge.



CAUTION

Perform the next step immediately to avoid dislodging the blue pellet. If any delay occurs, repeat the 20-minute centrifugation before proceeding.

- 16 Remove the cap mat and discard it.
- 17 Quickly invert the MSA4 plate and drain the liquid onto an absorbent pad to decant the supernatant. Then smack the plate down on a dry area of the pad, avoiding the liquid that was drained onto the pad.
- 18 Tap firmly several times for 1 minute or until all wells are devoid of liquid.



CAUTION

Keep the plate inverted. To ensure optimal performance, do not allow supernatant in wells to pour into other wells.

- 19 Leave the uncovered, inverted plate on the tube rack for 1 hour at room temperature to air dry the pellet.
You can expect to find blue pellets at the bottoms of the wells.

Figure 98 Uncovered MSA4 Plate Inverted for Air Drying

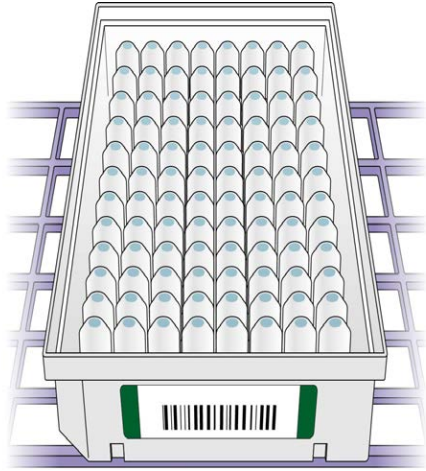

CAUTION

Do not overdry the pellet. Pellets that are overdried are difficult to resuspend. Poorly resuspended samples lead to poor data quality.

- 20 Record the start and stop times on the lab tracking form.
- 21 Discard unused reagents in accordance with facility standards.
- 22 Do either of the following:
 - Proceed to *Resuspend DNA (Post-Amp)*.
 - If you do not plan to proceed to the next step immediately, seal the MSA4 plate with a new cap mat and store at -25°C to -15°C for no more than 24 hours.



SAFESTOPPING POINT

Now is a good stopping point in the process.

Verify MSA4 for Centrifugation (Illumina LIMS Only)

- 1 In the Illumina LIMS left pane, click **Infinium HD Methylation | Spin MSA4**.
- 2 Scan the barcodes of the MSA4 plates and click **Verify**, then click **Save**.
- 3 If the MSA4 plate is queued for centrifugation, a blue confirmation message appears at the top of the window.
- 4 If the MSA4 plate is not queued for centrifugation, a red error message appears at the

top of the window. Do *not* proceed with centrifugation. Instead, follow these steps to troubleshoot the problem:

- a Click the Reports tab in the upper-right corner.
- b In the left pane, click **Tracking Reports | Get Queue Status**.
- c Scan the plate barcode and click **Go**.
- d Note what step the plate is queued for, and proceed with that step.

For information about how to use Illumina LIMS, see the *Illumina LIMS User Guide*.

Resuspend DNA (Post-Amp)

RA1 is added to the MSA4 plate to resuspend the precipitated DNA samples.

Figure 99 Resuspending DNA

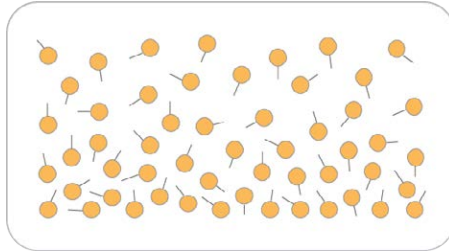

Estimated Time

Robot time:

- 10 minutes for 48 samples
- 15 minutes for 96 samples

Incubation time: 1 hour

Consumables

Item	Quantity	Storage	Supplied By
RA1	Bottle (9 ml) per 96 samples	-25°C to -15°C	Illumina



NOTE

Pour out only the recommended volume of RA1 needed for the suggested number of samples listed in the consumables table. Additional RA1 is used later in the XStain BeadChip step.

**WARNING**

This protocol uses an aliphatic amide that is a probable reproductive toxin. Personal injury can occur through inhalation, ingestion, skin contact, and eye contact. For more information, consult the material data safety sheet for this assay at www.illumina.com/msds. Dispose of containers and any unused contents in accordance with the governmental safety standards for your region.

Preparation

- 1 RA1 is shipped frozen. Gradually warm the reagent to room temperature, preferably in a 20°C to 25°C water bath. Gently mix to dissolve any crystals that might be present.
- 2 If you stored the MSA4 plate at -25°C to -15°C, thaw it to room temperature. Remove the cap mat and discard it.
- 3 Preheat the Illumina Hybridization Oven to 48°C.
- 4 Preheat the heat sealer. Allow 20 minutes.
- 5 On the lab tracking form, record:
 - Date/Time
 - Operator
 - Robot
 - RA1 bottle barcodes

**NOTE**

To record information about your assay such as operator information, start and stop times, and barcodes, use the lab tracking form provided at www.illumina.com/documentation. This form can be filled out and saved online, or printed and filled in by hand.

Use Fresh RA1 Reagent for Each Step

It is important to use fresh RA1 for each protocol step in the assay where it is required. RA1 that has been stored properly and has not been dispensed for use in either the XStain or Resuspension step is considered fresh RA1. After RA1 has been poured out into a reservoir and exposed to room temperature air for extended periods of time, it is no longer fresh.

To make best use of RA1, only pour out the amount needed for the current step. If you plan to perform additional assay steps requiring RA1 that same day, then leave the remaining thawed reagent in the original, closed bottle at room temperature until it is needed.

Otherwise, follow the standard RA1 storage procedures described in this assay guide for next-day processing and prolonged storage conditions.

Prepare Robot

For instructions on preparing the robot for use in a protocol, see the *Infinium Assay Lab Setup and Procedures Guide*.

Refer to the following figure throughout this protocol. Barcodes face to the right.

Figure 100 Tecan 8-Tip Robot (Resuspend MSA4 Setup)

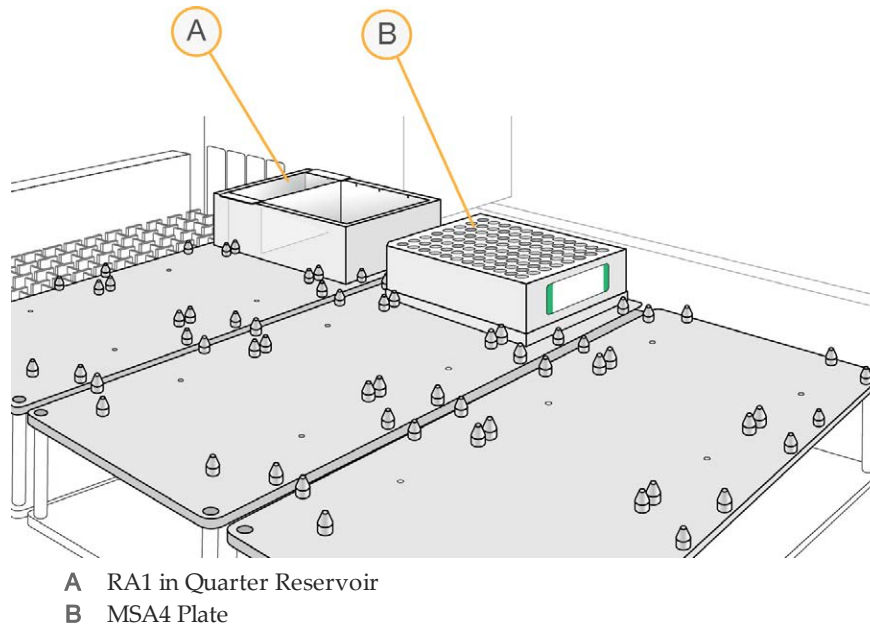

Steps to Resuspend the MSA4 Plate

- 1 At the robot PC, select **MSA4 Tasks | Resuspend MSA4**.
- 2 (Non-Illumina LIMS) In the **Basic Run Parameters** pane, change the value for **Number of MSA4 plates** and **Number of DNA samples per plate** to indicate the number of samples being processed.

**NOTE**

If you are using Illumina LIMS, you cannot change the number of DNA samples on this screen. However, the LIMS software processes the correct number of samples.

The robot PC updates the Required Run Items and the bed map to show the correct position of items on the robot bed. All barcodes must face to the right.

Figure 101 Resuspend MSA4 Screen

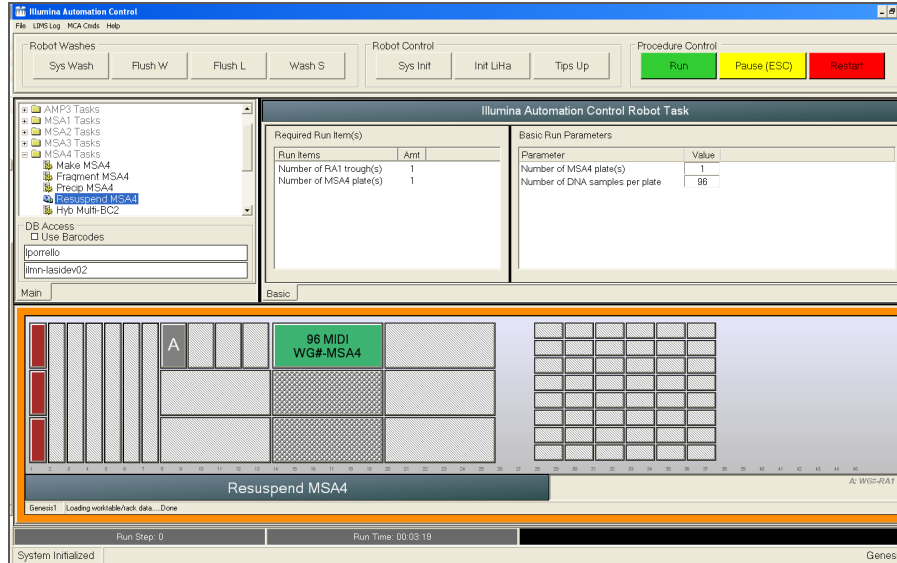

- 3 Place the MSA4 plate on the robot bed according to the bed map.
- 4 Place a quarter reservoir in the reservoir frame, according to the robot bed map, and add RA1 as follows:
 - 4.5 ml for 48 samples
 - 9 ml for 96 samples
- 5 In the lab tracking form, record the plate positions on the robot bed and RA1 barcodes.
- 6 Make sure that all items are placed correctly on the robot bed, all caps and seals have been removed, and all barcodes face to the right.

Start the Robot

- 1 (Non-Illumina LIMS) At the robot PC, click **Run**.
- 2 (Illumina LIMS) At the robot PC:
 - a Make sure that the **Use Barcodes** checkbox is checked.
 - b Click **Run** to start the process. Log in if prompted.

The robot PC sounds an alert and opens a message when the process is complete.
- 3 Click **OK** in the message box. Remove the MSA4 plate from the robot bed.
- 4 Apply a foil seal to the MSA4 plate by firmly holding the heat sealer block down for 3 full seconds.
- 5 Immediately remove the MSA4 plate from the heat sealer and forcefully roll the rubber plate sealer over the plate until you can see all 96 well indentations through the foil. Repeat application of the heat sealer if all 96 wells are not defined.
- 6 Place the sealed plate in the Illumina Hybridization Oven and incubate for 1 hour at 48°C.
- 7 Record the start and stop times on the lab tracking form.
- 8 Vortex the plate at 1800 rpm for 1 minute.
- 9 Pulse centrifuge at 280 × g.



NOTE

If you stored the DNA pellets at -25°C to -15°C for more than 72 hours, you might need to revortex and centrifuge until the pellets are resuspended.

- 10 Discard unused reagents in accordance with facility standards.
- 11 Do either of the following:
 - Proceed to *Hybridize to BeadChip (Post-Amp)*. If you plan to do so immediately, it is safe to leave the RA1 at room temperature.
 - If you do not plan to proceed to the next step immediately, store the sealed MSA4 plate at -25°C to -15°C for no more than 24 hours. Store at -80°C if storing for more than 24 hours. Store RA1 at -25°C to -15°C.



SAFESTOPPING POINT

Now is a good stopping point in the process.

Hybridize to BeadChips (Post-Amp)

In this process, the fragmented and resuspended DNA samples are dispensed onto the BeadChips. DNA-loaded BeadChips are placed into Hyb Chamber Inserts that are placed inside the Hyb Chambers.

After the DNA samples are loaded into the flow-through chambers, incubate the chambers for 16–24 hours at 48°C in the Illumina Hybridization Oven. Hybridization occurs during the incubation period. Each sample is hybridized to an individual section of the BeadChip.

Figure 102 Hybridizing DNA to BeadChip

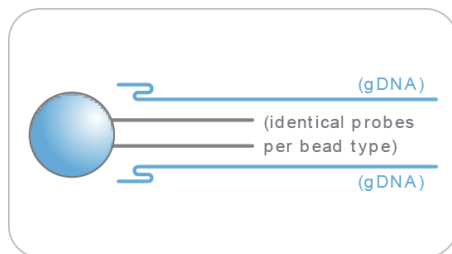

Estimated Time

Robot time:

- 10 minutes for 48 samples
- 15 minutes for 96 samples

Incubation time: 16–24 hours

Consumables for 8x1 HD BeadChip

Item	Quantity (per 96 Samples)	Storage	Supplied By
PB2	3 tubes	Room temperature	Illumina
BeadChips	12		Illumina
Hyb Chambers	3		Illumina
Hyb Chamber gaskets	3		Illumina
Hyb Chamber inserts	12		Illumina
Robot BeadChip Alignment Fixtures	6		Illumina
Robot Tip Alignment Guide-E	6		Illumina
EtOH	330 ml		User

Consumables 12x1 HD BeadChip

Item	Quantity (per 96 Samples)	Storage	Supplied By
PB2	2 tubes	Room temperature	Illumina
BeadChips	8	4°C	Illumina
Hyb Chambers	2		Illumina
Hyb Chamber gaskets	2		Illumina
Hyb Chamber inserts	8		Illumina
Robot BeadChip Alignment Fixtures	4		Illumina
EtOH	330 ml		User
Robot Tip Alignment Guide-B (one-piece guide)	8		Illumina
Illumina Robot Tip Alignment Guide-B inserts (for multipiece guide)	12		Illumina
Illumina Robot Tip Alignment Guide-B inserts (for multipiece guide)	4		Illumina



NOTE

Thaw all reagents completely at room temperature and allow to equilibrate. After thawed, gently invert each tube several times to mix the reagent thoroughly. Pulse centrifuge each tube to 280 × g to eliminate bubbles and collect reagent at the bottom of the tube.

Preparation

- 1 Preheat the heat block to 95°C.

- 2 Preheat the Illumina Hybridization Oven to 48°C and set the rocker speed to 5.
- 3 On the Lab Tracking Form, record the following:
 - Date/Time
 - Operator
 - Robot
 - PB2 tube barcode



NOTE

To record information about your assay such as operator information, start and stop times, and barcodes, use the lab tracking form provided at www.illumina.com/documentation. This form can be filled out and saved online, or printed and filled in by hand.



NOTE

Perform the Hyb Chamber assembly near the Hybridization Oven to minimize the distance you need to move the BeadChip loaded Hyb Chamber. Take care to keep the Hyb Chamber steady and level when lifting and moving. Avoid shaking and keep the Hyb Chamber parallel to the lab bench at all times.

Prepare the Robot Tip Alignment Guide

- 1 Make sure that you have the correct Robot Tip Alignment Guide for the Infinium assay you are running. The barcode says **Guide-B** for the 12x1 HD BeadChip or **Guide-E** for the 8x1 HD BeadChip.

Figure 103 One-Piece Guide-B Robot Tip Alignment Guide (for 12 x 1 HD BeadChips)

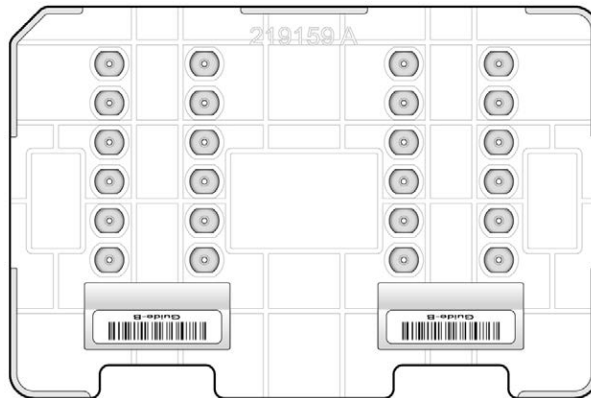

- 2 Wash and dry the entire one-piece Robot Tip Alignment Guide. See *Wash Robot Tip Alignment Guide* at the end of the *Hybridize to BeadChip* steps for washing instructions.
- 3 Place the assembled Robot Tip Alignment Guides on the lab bench until it is time to place them on the robot bed.

Assemble the Hybridization Chambers

- 1 Place the resuspended MSA4 plate on the heat block to denature the samples at 95°C for 20 minutes.
- 2 Remove the BeadChips from 2°C to 8°C storage, leaving the BeadChips in their plastic bags and mylar packages until you are ready to begin hybridization.
- 3 During the 20-minute incubation, prepare the Hyb Chambers. Place the following items on the benchtop for use in this procedure:

Figure 104 BeadChip Hyb Chamber Components

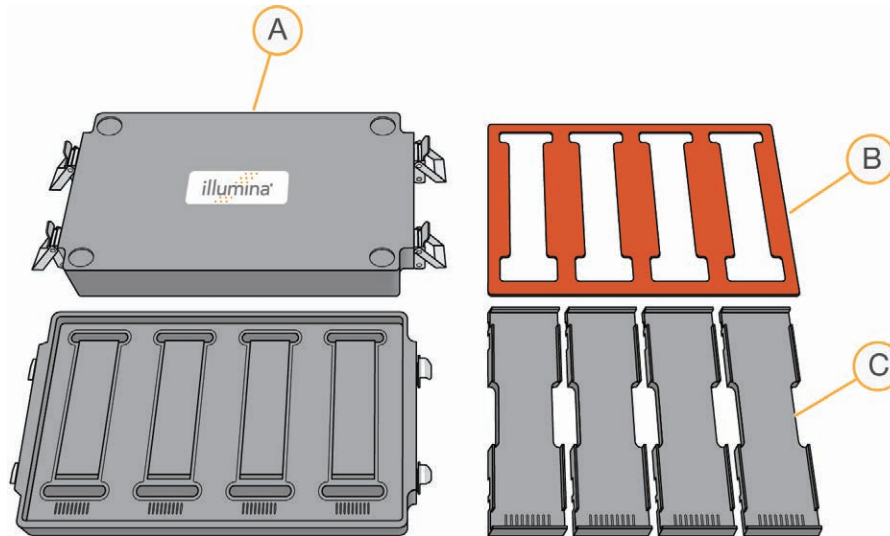

- A BeadChip Hyb Chambers
- B Hyb Chamber Gaskets
- C Hyb Chamber Inserts

**NOTE**

To ensure optimal results from Hyb Chambers, keep the Hyb Chamber lids and bases together. Adopt a labeling convention that keeps each Hyb Chamber base paired with its original lid. Check Hyb Chamber lid-base pairs regularly to make sure that the fit remains secure. Check hinges regularly for any signs of abnormal wear or loose fittings. It is important that the hinges provide adequate clamping strength to ensure an airtight seal between the lid and the base. Record the Hyb Chamber that was used for each BeadChip, so that Hyb Chambers can be investigated and evaluated in the event of sample evaporation or other lab processing anomalies.

- a Place the BeadChip Hyb Chamber gaskets into the BeadChip Hyb Chambers.
 - Match the wider edge of the Hyb Chamber Gasket to the barcode-ridge side of the Hyb Chamber.

Figure 105 Hyb Chamber and Gasket

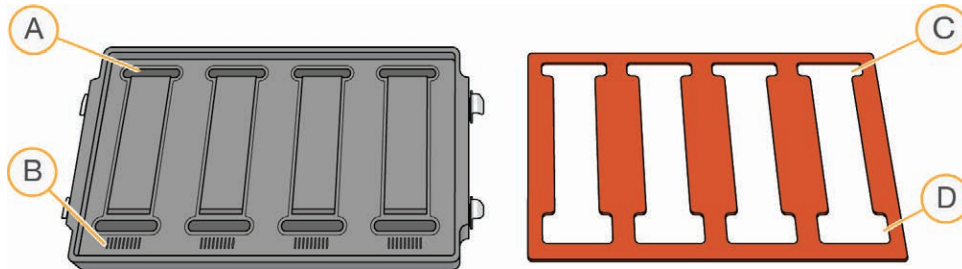

- A Reservoirs
- B Barcode Ridges
- C Narrower Edges
- D Wider Edges

- Lay the gasket into the Hyb Chamber, and then press it down all around.

Figure 106 Placing Gasket into Hyb Chamber

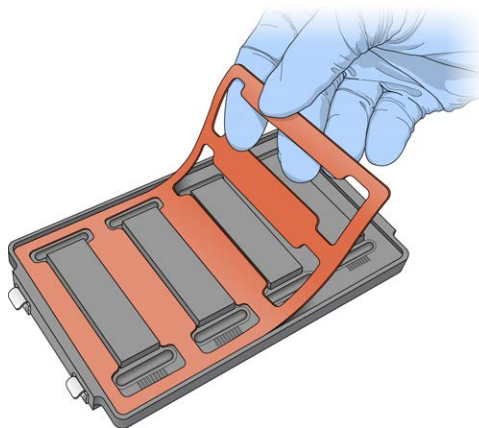

- Make sure that the Hyb Chamber gaskets are properly seated.

Figure 107 Hyb Chamber with Gasket in Place

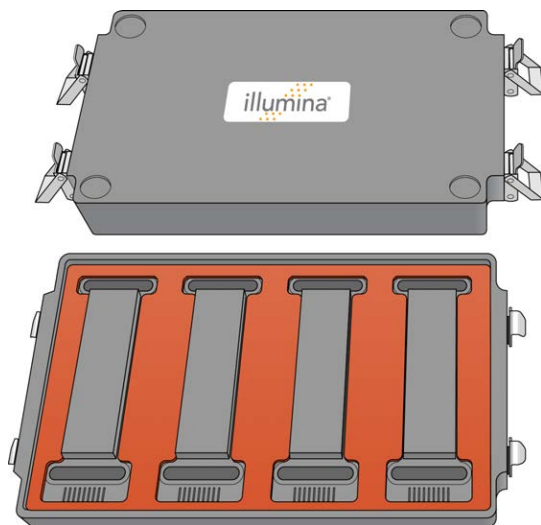

- b Dispense 400 μ l PB2 into the humidifying buffer reservoirs in the Hyb Chambers.

Figure 108 Dispensing PB2 into Hyb Chamber Reservoir

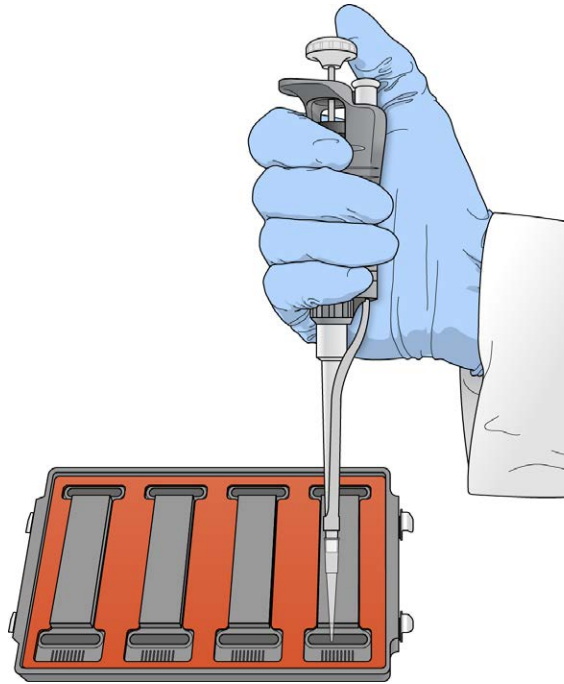

WARNING

Do not replace PB2 in the Hyb Chamber with RA1. RA1 decreases the stringency and can negatively affect sample call rates and logRdev. PB2 is formulated to produce the appropriate amount of humidity within the Hyb Chamber environment to prevent sample from evaporating during hybridization.

- c After you fill the Hyb Chamber reservoirs with PB2, place the lid on the Hyb Chamber right away to prevent evaporation. It is not necessary to lock the lid.
- d Leave the closed Hyb Chambers on the bench at room temperature until the BeadChips are loaded with DNA sample. Load BeadChips into the Hyb Chamber within 1 hour.



NOTE

You can also prepare the Hyb Chambers later, during the 30-minute cool down.

- 4 After the 20-minute incubation, remove the MSA4 plate from the heat block and place it on the benchtop at room temperature for 30 minutes.

- 5 After the 30-minute cool down, pulse centrifuge the MSA4 plate to $280 \times g$. Remove the foil seal.

Prepare the Robot

For instructions on preparing the robot for use in a protocol, see the *Infinium Assay Lab Setup and Procedures Guide*.

Refer to the following figure throughout this protocol. Barcodes face to the right.

Figure 109 Placing Alignment Fixtures and MSA4 Plate onto Robot Bed

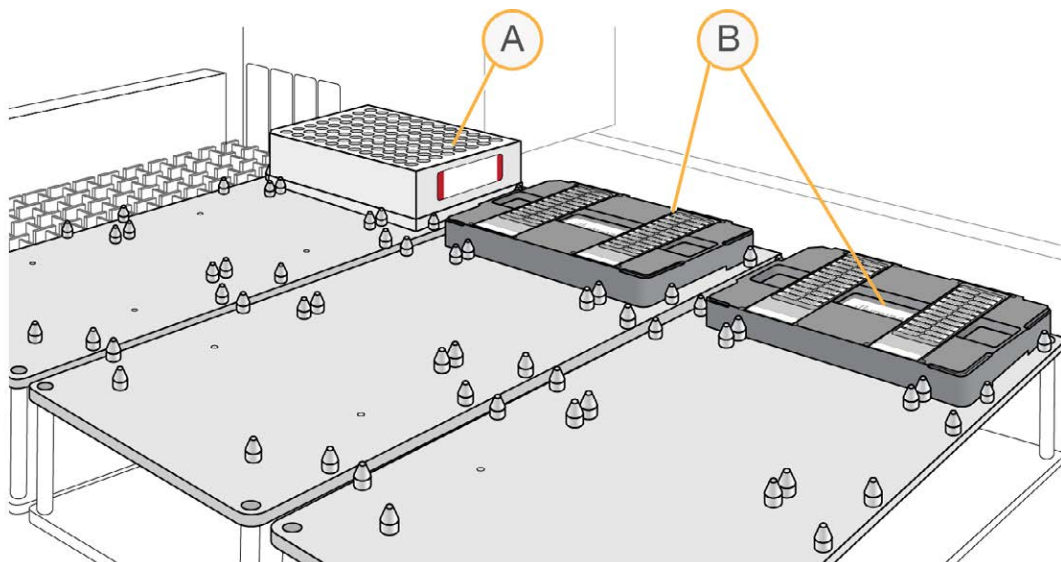

- A MSA4 Plate
- B Robot BeadChip Alignment Fixtures

Verify MSA4 and BeadChips for Hybridization (Illumina LIMS Only) [Optional]

- 1 In the Illumina LIMS left pane, click **Infinium HD Methylation | Confirm BeadChips for Hyb.**
- 2 Scan the barcode of the MSA4 plate.

- 3 Scan the barcodes of all the BeadChips you plan to hybridize with the plate. You can scan up to 24 BeadChips.



NOTE

Only scan BeadChips that have been accessioned into the system. The BeadChip type must match the type associated with this batch in Illumina LIMS.

- 4 Click **Verify**.
- 5 If the MSA4 plate and BeadChips are queued for hybridization, a blue confirmation message appears at the top of the window. Proceed to *Load BeadChips*.
If the MSA4 plate is not queued for hybridization, if any of the BeadChips have not been accessioned into the system, or if any of the BeadChips are the wrong type, a red error message appears at the top of the window. The error message indicates the first incorrect barcode that it finds. Do *not* proceed with hybridization; complete the following steps instead:
 - a Click the Reports tab in the upper-right corner.
 - b In the left pane, click **Tracking | Get Queue Status**.
 - c Scan the plate barcode and click **Go**.
 - d If the plate is queued for another step, proceed with that step.
- 6 If 1 of the BeadChips is not accessioned into the system, accession it and then repeat the verification step.
- 7 If 1 of the BeadChips is not the right type for this batch, accession a BeadChip that is the right type and repeat the verification step.
- 8 When the verification is successful, proceed to *Load BeadChips*.

Load BeadChips

- 1 Remove all BeadChips from their plastic bags and mylar packages.



CAUTION

Hold the BeadChip by the ends with your thumb and forefinger (thumb at the barcode end). Do not hold the BeadChip by the sides near the sample inlets. Avoid contacting the beadstripe area and sample inlets.

- 2 Place BeadChips into the Robot BeadChip Alignment Fixtures with the barcode end aligned to the ridges on the fixture.

Figure 110 Loading BeadChips in the Robot BeadChip Alignment Fixtures

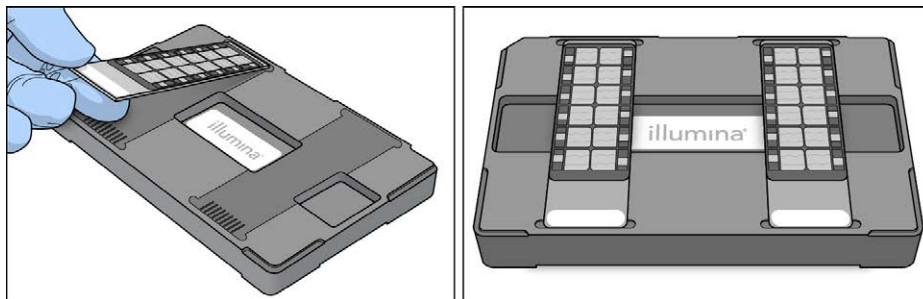

- 3 Stack the Robot BeadChip Alignment Fixtures and carry them to the robot.

Figure 111 Four Stacked Robot BeadChip Alignment Fixtures

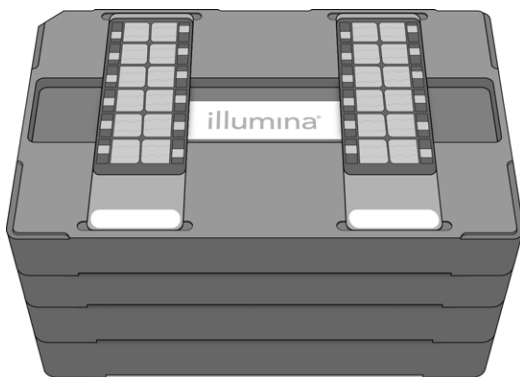

- 4 At the robot PC, select **MSA4 Tasks | Hyb-Multi BC2**.
- 5 Choose the appropriate BeadChip from the BeadChip Selection dialog box.
- 6 (Non-Illumina LIMS) In the Basic Run Parameters pane, change the value for **Number of MSA4 plates** and **Number of DNA samples per plate** to indicate the number of samples being processed.



NOTE

If you are using Illumina LIMS, you cannot change the number of DNA samples on this screen. However, the Illumina LIMS software processes the correct number of samples.

The robot PC updates the Required Run Item(s) and the bed map to show the correct position of items on the robot bed. All barcodes must face to the right.

Figure 112 Hyb Multi BeadChip Screen

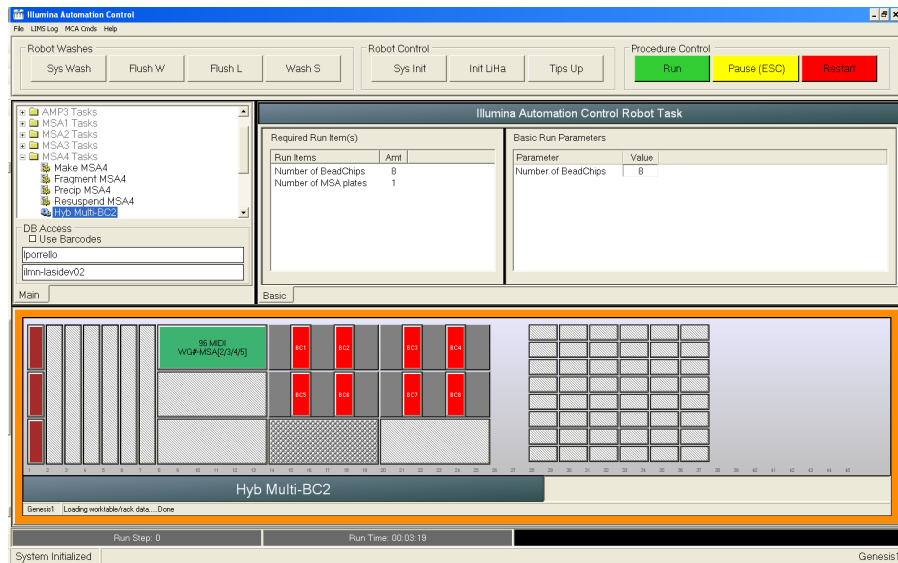

- 7 Place the Robot BeadChip Alignment Fixtures onto the robot bed according to the bed map.
- 8 On the lab tracking form, record the plate position on the robot bed, BeadChip serial numbers, and BeadChip positions.
- 9 Pulse centrifuge the MSA4 plate to $280 \times g$.
- 10 Place the MSA4 plate onto the robot bed according to the bed map. Remove the foil seal.

Start the Robot

- 1 (Non-Illumina LIMS) At the robot PC, click **Run**.
- 2 (Illumina LIMS) At the robot PC:
 - a Make sure that the **Use Barcodes** checkbox is selected.
 - b Click **Run** to start the process. Log in if prompted.
The robot scans the barcodes on the BeadChips to confirm the correct BeadChips are loaded. When the correct BeadChips are confirmed, the robot pauses.

- 3 Place the Robot Tip Alignment Guide on top of the Robot BeadChip Alignment Fixture, with the Guide-B barcode upside down and facing away from you. Push both the Robot Tip Alignment Guide and Robot BeadChip Alignment Fixture to the upper left corner in its section of the robot bed.
- 4 At the robot PC, click **OK** to confirm that you have placed the Robot Tip Alignment Guide on top of the Robot BeadChip alignment fixture. The robot scans the barcode on the Robot Tip Alignment Guide to confirm that the correct tip guide is being used.

Figure 113 Robot Tip Alignment Guides on Robot Bed

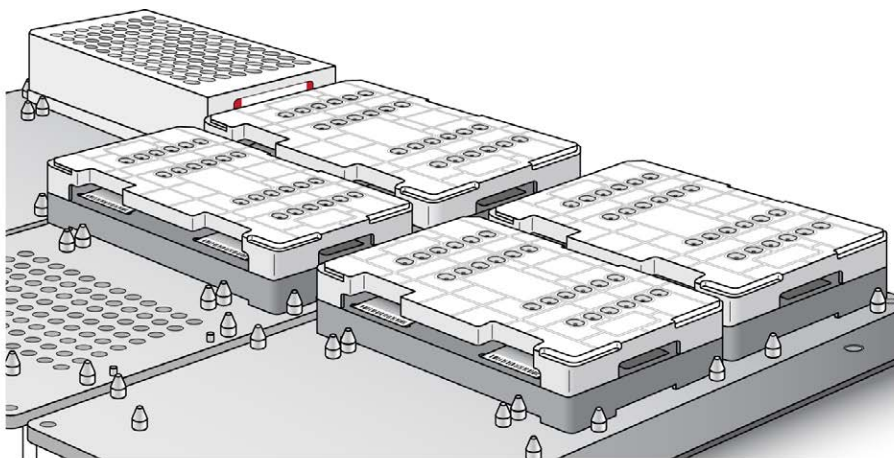

The robot dispenses sample to the BeadChips.

The robot PC sounds an alert and opens a message when the process is complete.

- 5 Click **OK** in the message box.
- 6 Carefully remove the Robot BeadChip alignment fixtures from the robot bed and visually inspect all sections of the BeadChips. Make sure that DNA sample covers all the sections of each bead stripe. Record any sections that are not completely covered.

Set up BeadChip for Hybridization

- 1 Make sure that the Illumina Hybridization Oven is set to 48°C.

**WARNING**

Keep Hyb Chambers at room temperature when you load the BeadChips. Do not place the Hyb Chambers in the Illumina Hybridization Oven before loading the BeadChips. If you heat the PB2 and then open the Hyb Chamber to add BeadChips, some of the PB2 evaporates, leading to a change in the osmolality of PB2 and an imbalance in the vapor pressure between PB2 and RA1.

**CAUTION**

Hold the BeadChip by the ends with your thumb and forefinger (thumb at the barcode end). Do not hold the BeadChip by the sides near the sample inlets. Avoid contacting the beadstripe area and sample inlets.

- Carefully remove each BeadChip from the Robot BeadChip alignment fixtures when the robot finishes.

**CAUTION**

For optimal performance, take care to keep the Hyb Chamber inserts containing BeadChips steady and level when lifting or moving. Avoid shaking and always keep parallel to the lab bench. Do not hold by the sides near the sample inlets.

- Calibrate the Illumina Hybridization Oven with the Full-Scale Plus digital thermometer supplied with your system.
- Carefully place each BeadChip in a Hyb Chamber insert, orienting the barcode end so that it matches the barcode symbol on the insert.

Figure 114 Matching the Barcode End to the Insert Fixture

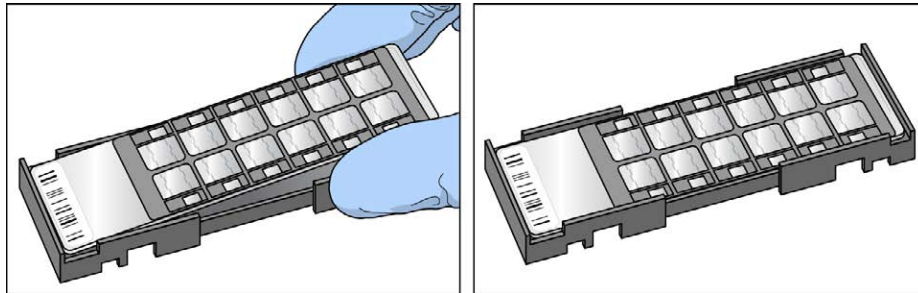

- Load the Hyb Chamber inserts containing loaded BeadChips inside the Illumina Hyb Chamber. Position the barcode over the ridges indicated on the Hyb Chamber.

Figure 115 Placing Hyb Chamber Inserts into Hyb Chamber

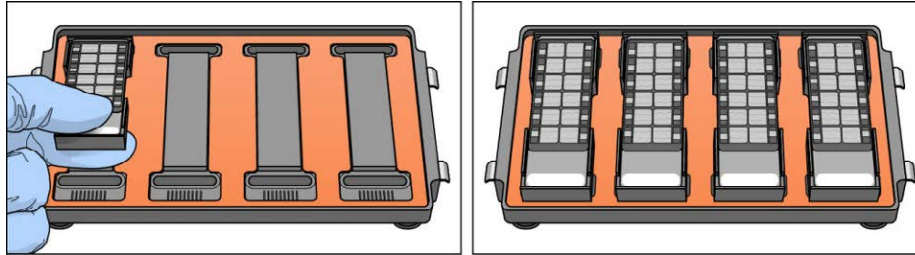

- 6 Make sure that Hyb Chamber inserts are seated properly.
- 7 (Illumina LIMS) In the Illumina LIMS left pane click **Infinium HD Methylation | Infinium Prepare Hyb Chamber**.
- 8 Scan the barcodes of the PB2 tubes and scan the BeadChip barcodes. Click **Verify**, and then click **Save**.
- 9 Position the lid onto the Hyb Chamber by applying the backside of the lid first and then slowly bringing down the front end to avoid dislodging the Hyb Chamber inserts.

Figure 116 Seating Lid onto Hyb Chamber

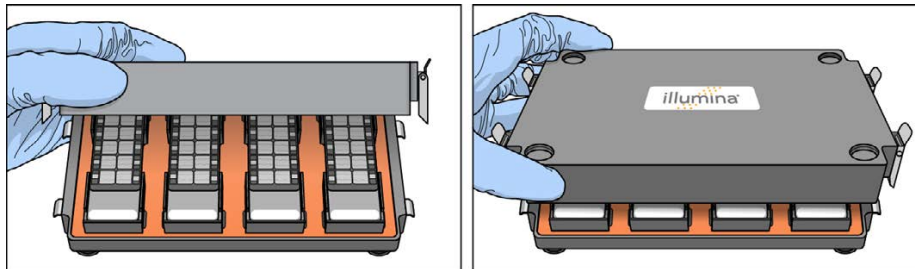

- 10 Close the clamps on both sides of the Hyb Chamber so that the lid is secure and even on the base (no gaps).
It is best to close them in a kitty-corner fashion, closing first the top left clamp, then the bottom right, then the top right followed by the bottom left.



NOTE

Keep the Hyb Chamber steady and level when moving it or transferring it to the Illumina Hybridization Oven.

- 11 Place the Hyb Chamber in the 48°C Illumina Hybridization Oven with the clamps on the left and right sides of the oven and the Illumina logo facing you.

Figure 117 Hyb Chamber Correctly Placed in Hyb Oven

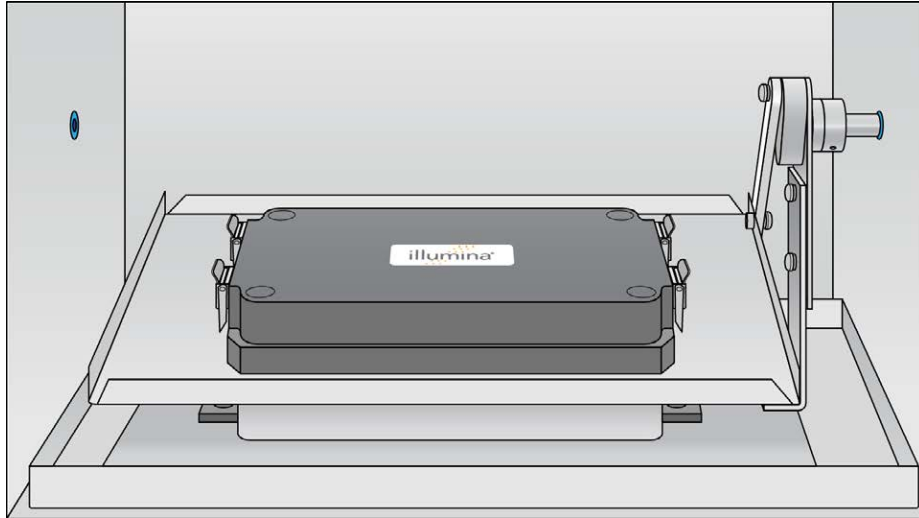

NOTE

If you are stacking multiple Hyb Chambers in the Illumina Hybridization Oven, fit the feet of the top Hyb Chamber into the matching indents on the lid of the Hyb Chamber below it. The fitted feet and lid hold the Hyb Chambers in place while they are rocking. You can stack up to 3 Hyb Chambers per row for a maximum of 6 Hyb Chambers total in the Illumina Hybridization Oven.

Figure 118 Two Hyb Chambers Correctly Placed in Hyb Oven

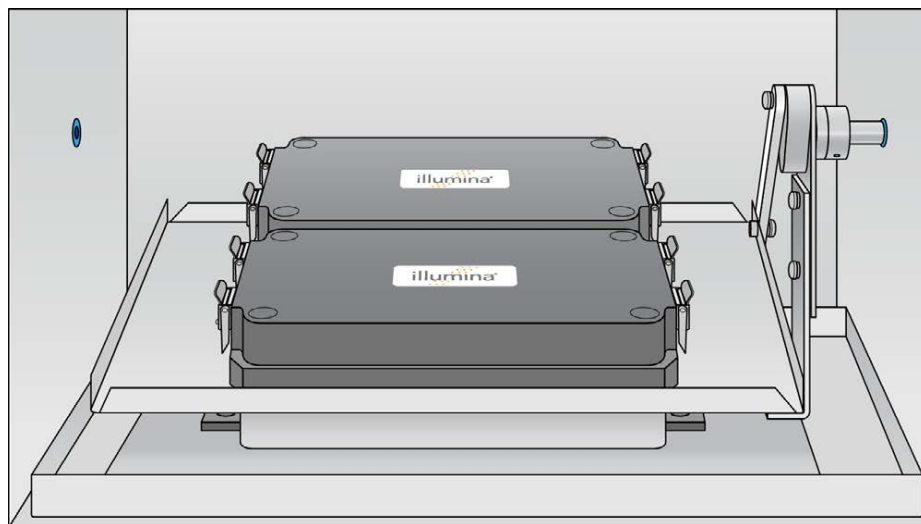
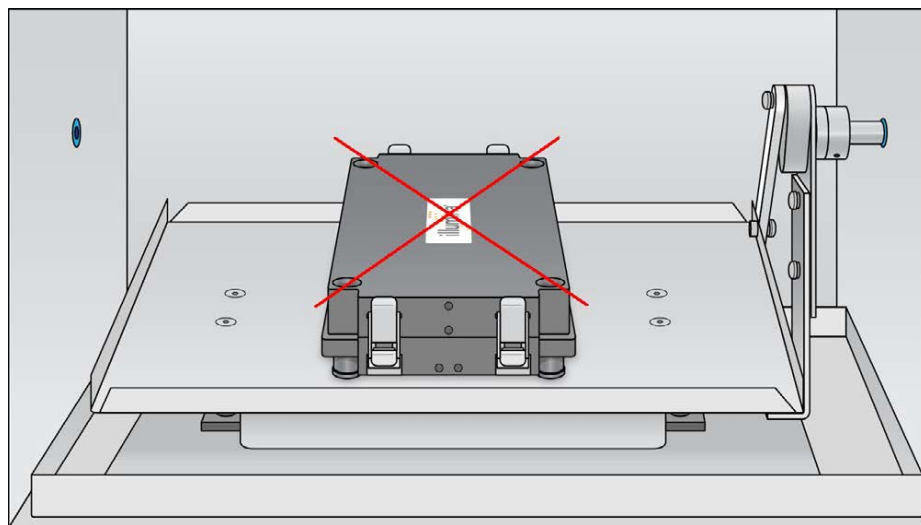

Figure 119 Incorrectly Placed Hyb Chamber



- 12 [Optional] Start the rocker, setting the speed to 5.

**OVERNIGHT INCUBATION**

Incubate at 48°C for at least 16 hours but no more than 24 hours.

- 13 Record the start and stop times on the lab tracking form.
- 14 Proceed to *Wash BeadChips (Post-Amp)* after the overnight incubation.

Resuspend XC4 Reagent for XStain BeadChip

Keep the XC4 in the bottle in which it was shipped until you are ready to use it. In preparation for the XStain protocol, follow these steps to resuspend the XC4 reagent.

- 1 Add 330 ml 100% EtOH to the XC4 bottle, for a final volume of 350 ml. Each XC4 bottle has enough solution to process up to 24 BeadChips.
- 2 Shake the XC4 bottle vigorously to ensure complete resuspension. After it is resuspended, use XC4 at room temperature. You can store it at 2°C to 8°C for 2 weeks if unused.

Wash the Robot Tip Alignment Guide

For optimal performance, wash and dry the Robot Tip Alignment Guides after every run.

- 1 Soak the tip guide inserts in a 1% aqueous Alconox solution (1 part Alconox to 99 parts water) using a 400 ml Pyrex beaker for 5 minutes.

**NOTE**

Do not use bleach or ethanol to clean the tip guide inserts.

- 2 After the 5 minute soak in the 1% Alconox solution, thoroughly rinse the tip guides with DiH₂O at least 3 times to remove any residual detergent.
- 3 Dry the Robot Tip Alignment Guide using a Kimwipe or lint-free paper towels. Use a laboratory air gun to dry. Be sure to inspect the tip guide channels, including the top and bottom. Tip guides must be dry and free of any residual contaminants before next use.

Wash BeadChips (Post-Amp)

In this procedure, the BeadChips are prepared for the XStain process.

Remove the cover seals from the BeadChips and wash the BeadChips in 2 separate PB1 reagent washes. Then, assemble the BeadChips into flow-through chambers under the PB1 buffer.

Figure 120 Washing BeadChip

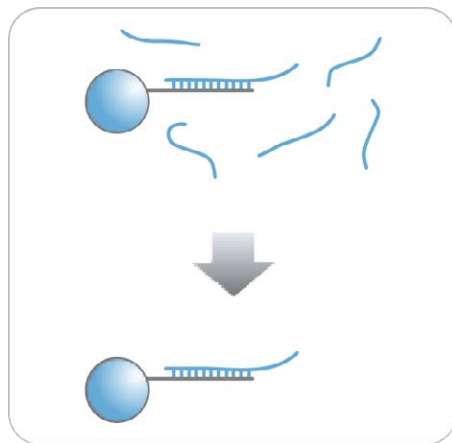

Estimated Time

- 20 minutes for 4 BeadChips
- 30 minutes for 8 BeadChips

Consumables

Item	Quantity	Storage	Supplied By
PB1	550 ml for 1 alignment fixture 700 ml for 2 alignment fixtures 850 ml for 3 alignment fixtures	Room temperature	Illumina
Multisample BeadChip alignment fixture	1 (per 8 BeadChips)		Illumina
Te-Flow flow-through chambers, with black frames, spacers, glass back plates, and clamps	1 (per BeadChip)		Illumina
Wash dish	2 (up to 8 BeadChips)		Illumina
Wash rack	1 (up to 8 BeadChips)		Illumina



CAUTION

Pour only the recommended reagent volume needed for the suggested number of samples listed in the Consumables table of each section. Some reagents are used later in the protocol.



WARNING

This protocol uses an aliphatic amide that is a probable reproductive toxin. Personal injury can occur through inhalation, ingestion, skin contact, and eye contact. For more information, consult the material data safety sheet for this assay at www.illumina.com/msds. Dispose of containers and any unused contents in accordance with the governmental safety standards for your region.

Preparation

- 1 Remove each Hyb Chamber from the Illumina Hybridization Oven. Let cool on the benchtop for 30 minutes before opening.
- 2 Have ready on the lab bench:
 - a Two wash dishes:
 - Containing 200 ml PB1, and labeled as such
 - b Multi-Sample BeadChip Alignment Fixture
 - Using a graduated cylinder, fill with 150 ml PB1
 - c Te-Flow flow-through chamber components:
 - Black frames
 - Spacers (separated for ease of handling)
 - Clean glass back plates as directed in the *Infinium Lab Setup and Procedures Guide*.
 - Clamps
- 3 On the lab tracking form, record:
 - Date/Time
 - Operator
 - PB1 bottle barcode
 - Robot



NOTE

To record information about your assay such as operator information, start and stop times, and barcodes, use the lab tracking form provided at www.illumina.com/documentation. This form can be filled out and saved online, or printed and filled in by hand.

Verify Reagents and BeadChips for Washing (Illumina LIMS Only)

- 1 In the Illumina LIMS left pane, click **Infinium HD Methylation | Wash BeadChip**.
- 2 Scan the barcodes of the PB1.
- 3 Scan the BeadChip barcodes.
- 4 Click **Verify** and then click **Save**.

- 5 If the reagents are correct and the BeadChips are queued for washing, a blue confirmation message appears at the top of the window. Proceed to *Steps to Wash BeadChip*.
- 6 If any of the reagents are invalid, check the reagent type before rescanning. The reagent name (eg, PB1) appears at the end of the barcode. Make sure to scan the correct reagent into each box.
- 7 If any of the BeadChips are not queued for washing, a red error message appears at the top of the window. The error message indicates the first incorrect barcode that it finds. Do *not* proceed with washing. Instead, follow these steps to troubleshoot the problem:
 - a Click the Reports tab in the upper-right corner.
 - b In the left pane, click **Tracking Reports | Get Queue Status**.
 - c Scan the BeadChip barcode that appeared in the error message and click **Go**.
 - d Note what step the BeadChip is queued for, and proceed with that step.

For information about how to use Illumina LIMS, see the *Illumina LIMS User Guide*.

Steps to Wash BeadChips

- 1 Attach the wire handle to the rack and submerge the wash rack in the wash dish containing 200 ml PB1.

Figure 121 Wash Rack in Wash Dish Containing PB1



- 2 Remove the Hyb Chamber inserts from the Hyb Chambers.
- 3 Remove each BeadChip from the Hyb Chamber insert.
- 4 Remove the cover seal from each BeadChip.

**NOTE**

To make sure that no solution splatters on you, Illumina recommends removing the cover seal over an absorbent cloth or paper towels, preferably in a hood.

- a Using powder-free gloved hands, hold the BeadChip securely and by the edges in one hand. Avoid contact with the sample inlets. Make sure that the barcode is facing up and closest to you, and that the top side of the BeadChip is angled slightly away from you.
- b Remove the entire seal in a single, continuous motion. Start with a corner on the barcode end and pull with a continuous upward motion away from you and towards the opposite corner on the top side of the BeadChip.

Figure 122 Removing the Cover Seal

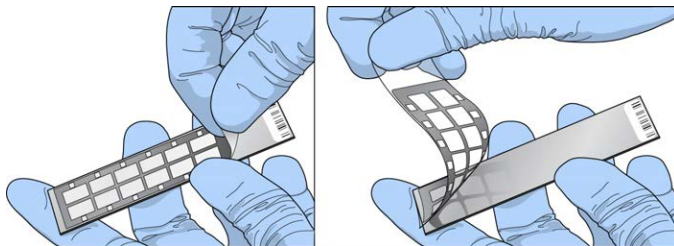

- c Discard the cover seal.

**CAUTION**

Do not touch the arrays!

- 5 Immediately and carefully slide each BeadChip into the wash rack, making sure that the BeadChip is submerged in the PB1.

Figure 123 Submerging BeadChips in Wash Dish Containing PB1



- 6 Repeat steps 4 through 5 until all BeadChips (a maximum of 8) are transferred to the submerged wash rack.
- 7 After all BeadChips are in the wash rack, move the wash rack up and down for 1 minute, breaking the surface of the PB1 with gentle, slow agitation.
- 8 Move the wash rack to the other wash dish containing clean PB1. Make sure the BeadChips are submerged.
- 9 Move the wash rack up and down for 1 minute, breaking the surface of the PB1 with gentle, slow agitation.
- 10 When you remove the BeadChips from the wash rack, inspect them for remaining residue.



NOTE

Residue that can adversely affect results is sometimes left on BeadChips after seals are removed. If there is residue left on the BeadChips after the second PB1 wash, use a 200 μ l pipette tip to slowly and carefully scrape the residue away from the bead sections. Use a new pipette tip for each BeadChip. Then, continue with the protocol.

- 11 For each additional set of 8 BeadChips:

- a Assemble the flow-through chambers for the first 8 BeadChips, as described in *Assemble Flow-Through Chambers* on page 78.
- b Repeat the wash steps in this section to wash the next set of 8 BeadChips.

Assemble Flow-Through Chambers



NOTE

Confirm that you are using the correct Infinium standard glass back plates and spacers before assembling the flow-through chambers. Refer to the following image for the correct flow-through chamber components.

Figure 124 Correct Standard Back Plates and Spacers

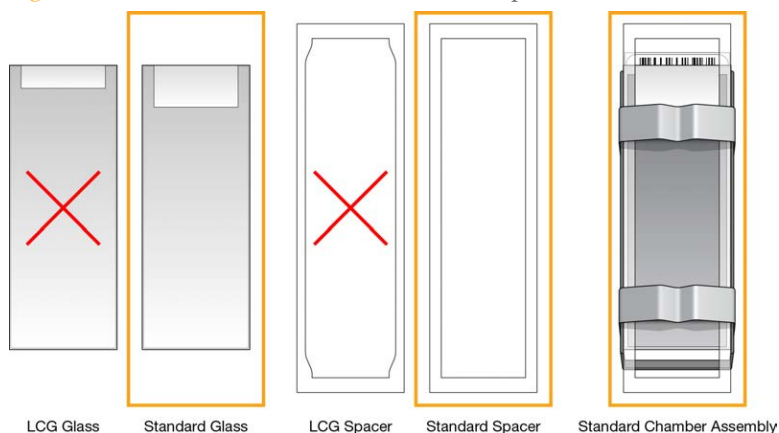

- 1 If you have not done so, fill the BeadChip alignment fixture with 150 ml PB1. If you plan to process more than 4 BeadChips, this 150 ml of PB1 can be reused for an additional set of 4 BeadChips. Use 150 ml of fresh PB1 for every additional set of 8 BeadChips.
- 2 For each BeadChip to be processed, place a black frame into the BeadChip alignment fixture prefilled with PB1.

Figure 125 Placing Black Frames into BeadChip Alignment Fixture



- 3 Place each BeadChip to be processed into a black frame, aligning its barcode with the ridges stamped onto the alignment fixture.



NOTE

Inspect the surface of each BeadChip for residue left by the seal. Use a pipette tip to remove any residue under buffer and be careful not to scratch the bead area.

Figure 126 Placing BeadChip into Black Frame on Alignment Fixture



- 4 Place a clear spacer onto the top of each BeadChip. Use the alignment fixture grooves to guide the spacers into proper position.

**NOTE**

Be sure to use the clear plastic spacers, not the white ones.

Figure 127 Placing Clear Plastic Spacer onto BeadChip

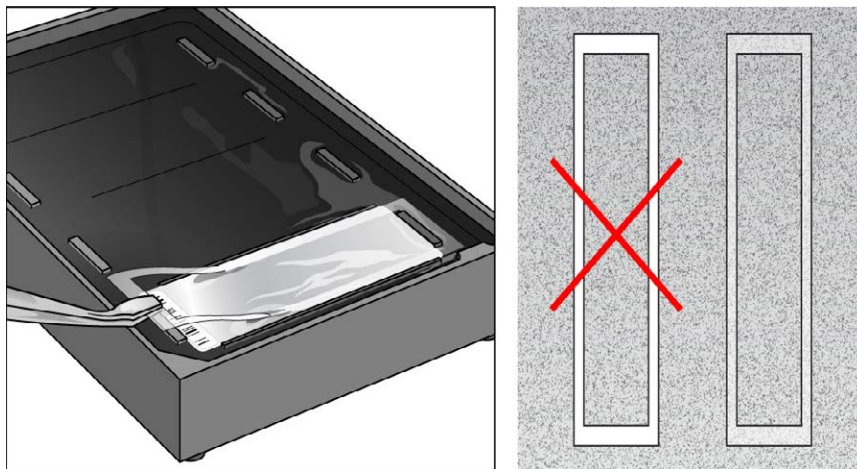

- 5 Place the alignment bar onto the alignment fixture.
The groove in the alignment bar fits over the tab on the alignment fixture.

Figure 128 Placing Alignment Bar onto Alignment Fixture

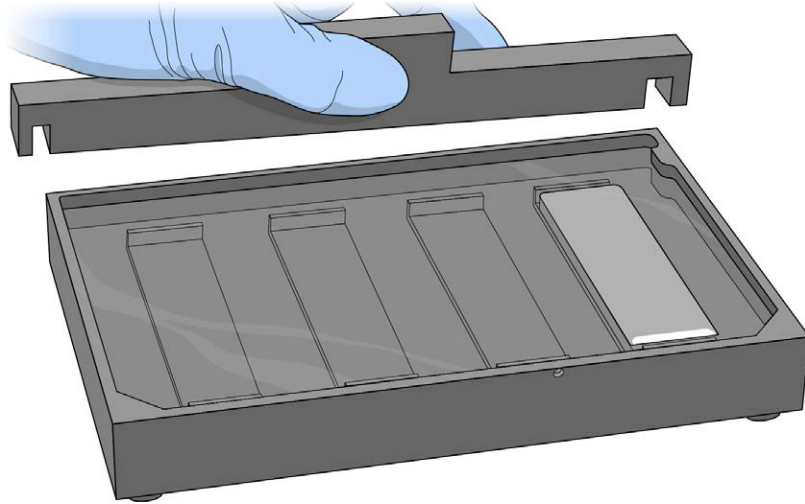

- Place a clean glass back plate on top of the clear spacer covering each BeadChip. The plate reservoir is at the barcode end of the BeadChip, facing inward to create a reservoir against the BeadChip surface.

Figure 129 Placing Glass Back Plate onto BeadChip

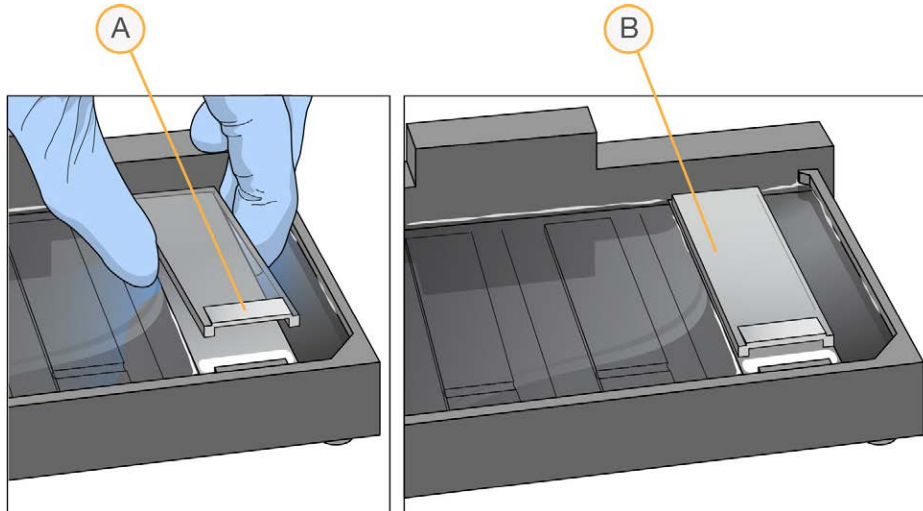

- A Reservoir at Barcode End of Glass Back Plate
 - B Glass Back Plate in Position
- 7 Attach the metal clamps to the flow-through chambers as follows:
- a Gently push the glass back plate against the alignment bar with one finger.
 - b Place the first metal clamp around the flow-through chamber so that the clamp is approximately 5 mm from the top edge.
 - c Place the second metal clamp around the flow-through chamber at the barcode end, approximately 5 mm from the reagent reservoir.

Figure 130 Securing Flow-Through Chamber Assembly with Metal Clamps

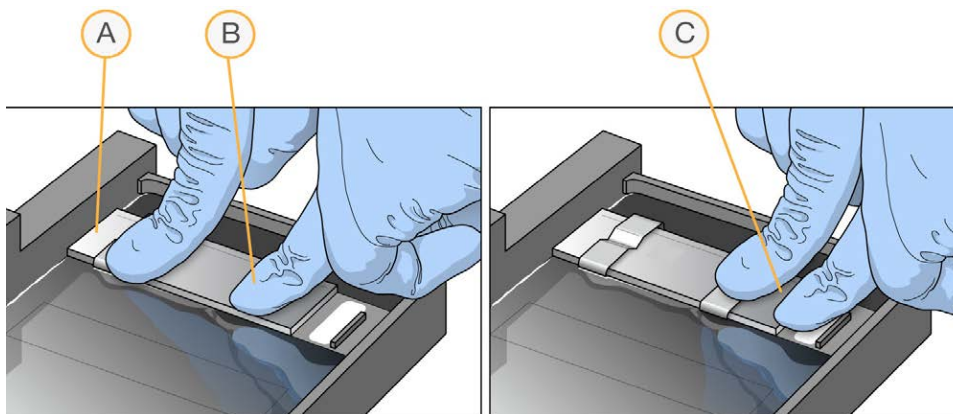

- A One Stripe Shows Between First Clamp and Alignment Bar
 - B Glass Back Plate Pressed Against Alignment Bar
 - C No Stripes Show Between Second Clamp and Barcode
- 8 Using scissors, trim the ends of the clear plastic spacers from the flow-through chamber assembly. Slip scissors up over the barcode to trim the other end.

Figure 131 Trimming Spacer Ends from Flow-Through Chamber Assembly

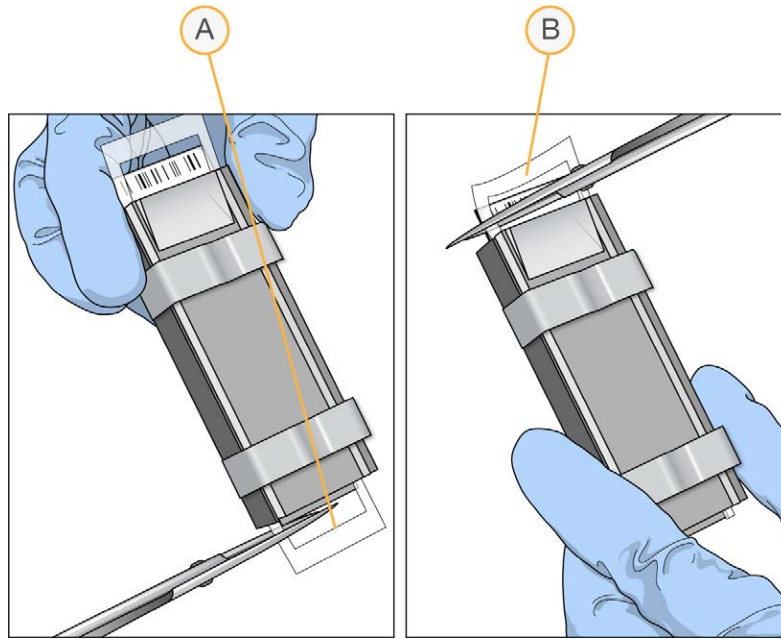

- A Trim Spacer at Non-Barcode End of Flow-Through Chamber
 B Trim Spacer at Barcode End of Flow-Through Chamber

- 9 **Immediately** wash the Hyb Chamber reservoirs with DiH_2O and scrub them with a small cleaning brush, ensuring that no PB2 remains in the Hyb Chamber reservoir.



CAUTION

It is important to wash the Hyb Chamber reservoirs immediately and thoroughly to make sure that no traces of PB2 remain in the wells.

- 10 Discard unused reagents in accordance with facility standards.
 11 Proceed to *Extend and Stain (XStain) BeadChip (Post-Amp)*.



CAUTION

Place all assembled flow-through chambers on the lab bench in a horizontal position while you perform the preparation steps for the XStain BeadChip. Do not place the flow-through chambers in the chamber rack until the preparation is complete.

Extend and Stain (XStain) BeadChip (Post-AMP)

Following hybridization, RA1 reagent is used to wash away unhybridized and non-specifically hybridized DNA sample. XC1 and XC2 are added to condition the BeadChip surface for the extension reaction. TEM reagents are dispensed into the Flow-Through Chambers to perform single-base extension of primers hybridized to DNA on the BeadChip. This reaction incorporates labeled nucleotides into the extended primers. 95% formamide/1 mM EDTA is added to remove the hybridized DNA. After neutralization using the XC3 reagent, the labeled extended primers undergo a multi-layer staining process on the Chamber Rack. Next, the Flow-Through Chambers are disassembled. The BeadChips are washed in the PB1 reagent, and then coated with XC4 reagent and dried.

Figure 132 Extending and Staining BeadChip

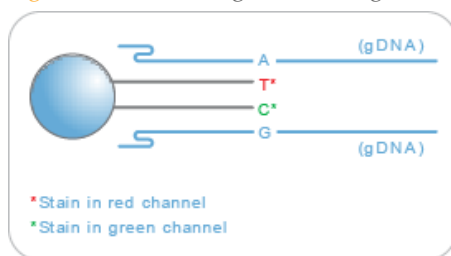

Estimated Time

Robot time:

- 2 hours and 10 minutes for 8 BeadChips
- 2 hours and 25 minutes for 16 BeadChips
- 2 hours and 40 minutes for 24 BeadChips

Dry time: 55 minutes

Consumables

Item	Quantity (Per 8 BeadChips)	Storage	Supplied By
RA1	10 ml	-25°C to -15°C	Illumina

Item	Quantity (Per 8 BeadChips)	Storage	Supplied By
XC1	2 tubes	-25°C to -15°C	Illumina
XC2	2 tubes	-25°C to -15°C	Illumina
TEM	2 tubes	-25°C to -15°C	Illumina
XC3	75 ml	Room temperature	Illumina
STM (Make sure that all STM tubes indicate the same stain temperature on the label)	2 tubes	-25°C to -15°C	Illumina
ATM	2 tubes	-25°C to -15°C	Illumina
PB1	310 ml	Room temperature	Illumina
XC4	310 ml	-25°C to -15°C	Illumina
Alconox Powder Detergent	as needed	Room temperature	User
EtOH	as needed	Room temperature	User
95% formamide/1 mM EDTA	15 ml	-25°C to -15°C	User

**CAUTION**

Pour out only the recommended reagent volume needed for the suggested number of beachships listed in the consumables table of each section. Some of the reagents are used later in the protocol.

**NOTE**

It is important to use fresh RA1 for each protocol step in the assay where it is required. RA1 that has been stored properly and has not been dispensed for use in either the XStain or Resuspension step is considered fresh RA1. After RA1 has been poured out into a reservoir and exposed to room temperature air for extended periods of time, it is no longer fresh.

**WARNING**

This protocol uses an aliphatic amide that is a probable reproductive toxin. Personal injury can occur through inhalation, ingestion, skin contact, and eye contact. For more information, consult the material data safety sheet for this assay at www.illumina.com/msds. Dispose of containers and any unused contents in accordance with the governmental safety standards for your region.

Preparation

- 1 RA1 is shipped frozen. Gradually warm the reagent to room temperature, preferably in a 20°C to 25°C water bath. Gently mix to dissolve any crystals that may be present.
- 2 Place all reagent tubes in a rack in the order in which they will be used. If frozen, allow them to thaw to room temperature, and then gently invert the reagent tubes at least 10 times to mix contents.

Figure 133 XStain BeadChip Reagent Tubes and Bottles

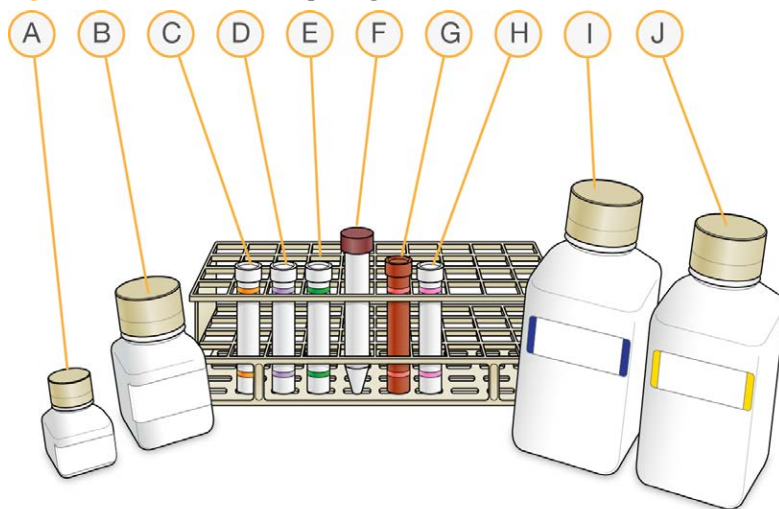

- A RA1
- B XC3
- C XC1
- D XC2
- E TEM
- F 95% Formamide / 1mM EDTA

- G STM
- H ATM
- I PB1
- J XC4

- 3 On the lab tracking form, record:
 - Date/Time
 - Operator
 - Robot
 - RA1 barcode
 - XC3 barcode
 - XC1 barcodes
 - XC2 barcodes
 - TEM barcodes
 - STM barcodes
 - ATM barcodes
 - PB1 barcode
 - XC4 barcodes



NOTE

To record information about your assay such as operator information, start and stop times, and barcodes, use the lab tracking form provided at www.illumina.com/documentation. This form can be filled out and saved online, or printed and filled in by hand.

Set Up Chamber Rack

- 1 Make sure that the water circulator reservoir is filled with water to the appropriate level. See the *VWR Operator Manual*, VWR part # 110-229.
- 2 Turn on the water circulator and set it to a temperature that brings the chamber rack to 44°C at equilibrium.
This temperature can vary depending on facility ambient conditions.

Figure 134 Water Circulator Connected to Chamber Rack

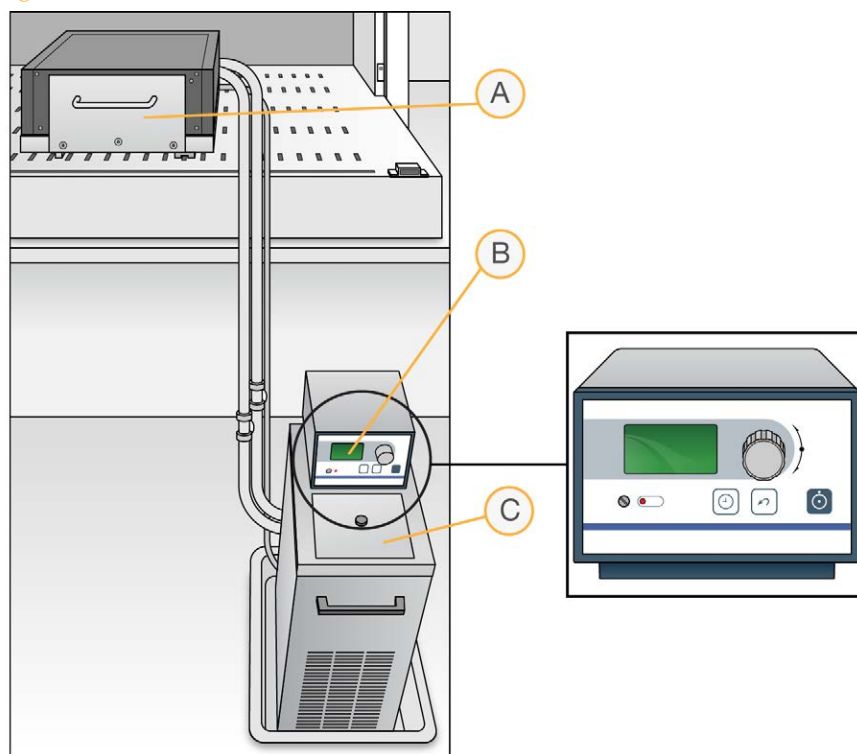

- A Chamber Rack
- B Water Circulator with Programmable Temperature Controls
- C Reservoir Cover

- 3 Confirm the temperature using the temperature probe for the chamber rack. The temperature displayed on the water circulator LCD screen might differ from the actual temperature on the chamber rack.
- 4 Make sure that you remove bubbles trapped in the chamber rack *each time* you run this process. Follow instructions in the *Te-Flow (Tecan Flow-Through Module) Operating Manual*, Tecan Doc ID 391584.
- 5 Use the Illumina Temperature Probe in several locations to make sure that the chamber rack is at 44°C. Make sure that all locations are at 44°C ± 0.5°C.



NOTE

Do not leave the temperature probe in the first 3 rows of the chamber rack. Reserve this space for BeadChips.

Figure 135 Illumina Temperature Probe and Temperature Probe in Chamber Rack

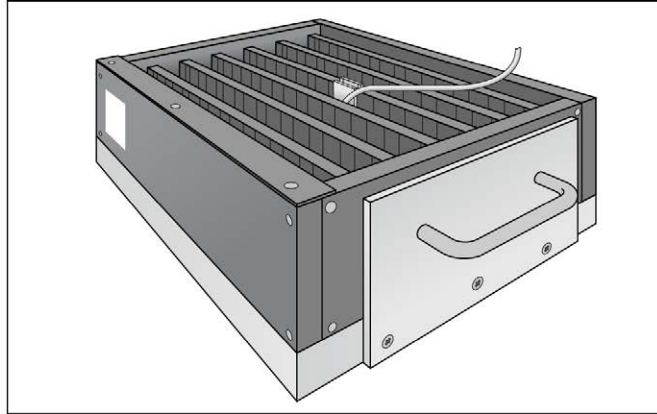
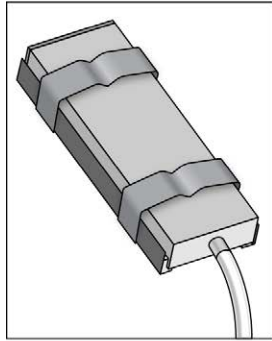

- 6 For accurate temperature measurement, make sure that the Illumina Temperature Probe is touching the base of the chamber rack.

Prepare Robot

For instructions on preparing the robot for use in a protocol, see the *Infinium Assay Lab Setup and Procedures Guide*

Refer to the following figure throughout this protocol.

Figure 136 Tecan 8-Tip Robot (XStain BeadChip Setup)

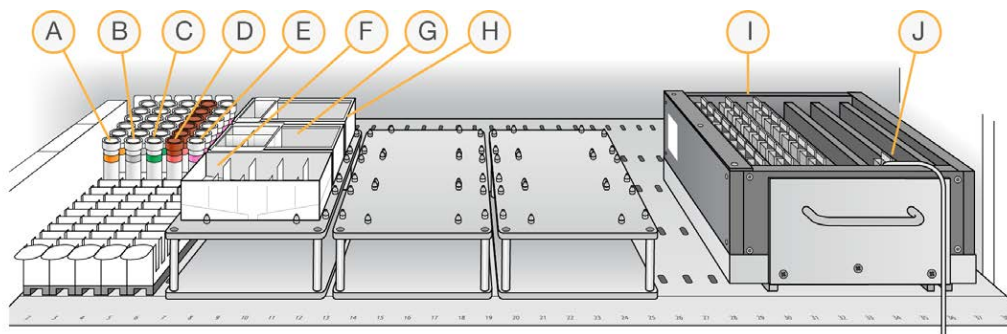

- A XC1
- B XC2
- C TEM
- D STM
- E ATM
- F XC3 in Full Reservoir
- G RA1 in Half Reservoir
- H 95% Formamide / 1 mM EDTA in Quarter Reservoir
- I 24 BeadChips in Chamber Rack
- J Temperature Probe

Single-Base Extension and Stain



CAUTION

The remaining steps must be performed without interruption.

- 1 Slide the chamber rack into column 36 on the robot bed. Make sure that it is seated properly.
- 2 At the robot PC, select **XStain Tasks | XStain HD BeadChip**.

- 3 In the Basic Run Parameters pane, enter the number of BeadChips. You can process up to 24 BeadChips in the XStain BeadChip process. The robot PC updates the Required Run Items and the bed map to show the correct position of items on the robot bed. All barcodes must face to the left.

Figure 137 XStain BeadChip Screen

- 4 If you plan on imaging the BeadChip immediately after the staining process, turn on the iScan or HiScan now to allow the lasers to stabilize.
- 5 Place a quarter reservoir in the reservoir frame, according to the robot bed map, and add 95% formamide/1 mM EDTA as follows:
 - 15 ml to process 8 BeadChips
 - 17 ml to process 16 BeadChips
 - 25 ml to process 24 BeadChips
- 6 Place a half reservoir in the reservoir frame, according to the robot bed map, and add RA1 in the following volumes:
 - 10 ml to process 8 BeadChips
 - 20 ml to process 16 BeadChips
 - 30 ml to process 24 BeadChips
- 7 Place a full reservoir in the reservoir frame, according to the robot bed map, and add XC3 in the following volumes:
 - 50 ml to process 8 BeadChips
 - 100 ml to process 16 BeadChips
 - 150 ml to process 24 BeadChips
- 8 Place each reagent tube (XC1, XC2, TEM, STM, ATM) in the robot tube rack according to the bed map, and remove their caps.
- 9 Make sure that all items are placed properly on the robot bed, all caps and seals have been removed, and all the barcodes face to the right.

Start Robot

- 1 (Non-Illumina LIMS) At the robot PC, click **Run**.
- 2 (Illumina LIMS) At the robot PC:

- a Make sure that the **Use Barcodes** checkbox is selected.
 - b In the **Basic Run Parameters** pane, change the value for **Number of BeadChips** to indicate the number of BeadChips being processed.
 - c Click **Run** to start the process. Log in if prompted.
- 3 When prompted, enter the stain temperature indicated on the STM tube.

NOTE
If you are using Illumina LIMS, you are not prompted to enter the staining temperature. Illumina LIMS automatically sets the correct temperature based on the STM tube barcodes.
 - 4 When the prompt appears, wait for the Chamber Rack to reach 44°C. Do not load the BeadChips or click **OK** yet.
 - 5 When the temperature probe registers 44°C, click **OK**.
 - 6 When prompted, load the BeadChips and click **OK**.
 - 7 Place each assembled flow-through chamber in the first row of the chamber rack. Refer to the robot bed map for the correct layout.
 - 8 Make sure that each flow-through chamber is properly seated on its rack to allow adequate heat exchange between the rack and the chamber.
 - 9 Record the chamber rack position associated with each BeadChip on the lab tracking form.
 - 10 Click **OK**. A series of reactions begins, each with a wait time. Message boxes on the robot PC tell you which reaction is occurring and how long the wait time is.

Table 17 List of Reactions

#	Reagent	Wait Time
1	RA1	3 minutes
2	XC1	10 minutes
3	XC2	10 minutes
4	TEM	15 minutes
5	Formamide/EDTA	7 minutes

#	Reagent	Wait Time
6	XC3	2 minutes
7	STM	10 minutes
8	XC3	7 minutes
9	ATM	10 minutes
10	XC3	7 minutes
11	STM	10 minutes
12	XC3	7 minutes
13	ATM	10 minutes
14	XC3	7 minutes
15	STM	10 minutes
16	XC3	7 minutes

- When prompted, remove the BeadChips from the chamber rack immediately and place them horizontally on the lab bench at room temperature. Click **OK** in the message box.
- The robot PC sounds an alert and opens a message when the process is complete. Click **OK** to finish the process.

Verify Reagents and BeadChips for Coating (Illumina LIMS Only)

- In the Illumina LIMS left pane, click **Infinium HD Methylation | Coat BC2**.
- Scan the barcodes of the PB1.
- Scan the barcodes of the XC4.
- Scan the BeadChip barcodes.
- Click **Verify** and then click **Save**.

- 6 If the reagents are correct and the BeadChips are queued for coating, a blue confirmation message appears at the top of the window. Proceed to *Wash and Coat 8 BeadChips*.
- 7 If any of the reagents are invalid, check the reagent type before rescanning. The reagent name (eg, PB1) appears at the end of the barcode. Make sure to scan the correct reagent into each box.
- 8 If any of the BeadChips are not queued for coating, a red error message appears at the top of the window. The error message indicates the first incorrect barcode that it finds. Do *not* proceed with coating. Instead, follow these steps to troubleshoot the problem:
 - a Click the Reports tab in the upper-right corner.
 - b In the left pane, click **Tracking Reports | Get Queue Status**.
 - c Scan the BeadChip barcode that appeared in the error message and click **Go**.
 - d Note what step the BeadChip is queued for, and proceed with that step.

For information about how to use Illumina LIMS, see the *Illumina LIMS User Guide*.

Wash and Coat 8 BeadChips

Before starting the Wash and Coat process, read these important notes:

- ▶ Take the utmost care to minimize the chance of lint or dust entering the wash dishes, which could transfer to the BeadChips. Place wash dish covers on wash dishes when stored or not in use. Clean wash dishes with low-pressure air to remove particulates before use.
- ▶ In preparation for XC4 BeadChip coating, wash the tube racks and wash dishes thoroughly before and after use. Rinse with DI water. Immediately following wash, place racks and wash dishes upside down on a wash rack to dry.
- ▶ Place Kimwipes in 3 layers on the lab bench. Place a tube rack on top of these Kimwipe layers. Do not place on absorbent lab pads. You will place the staining rack containing BeadChips on this tube rack after removing it from the XC4 wash dish.
- ▶ Prepare an additional clean tube rack that fits the internal dimensions of vacuum desiccator for removal of the BeadChips. Allow one rack per 8 BeadChips. No Kimwipes are required under this tube rack.

Equipment Needed

Place the following items on the bench:

- ▶ 1 staining rack

- ▶ 1 vacuum desiccator
- ▶ 1 tube rack
- ▶ Self-locking tweezers
- ▶ Large Kimwipes
- ▶ Vacuum hose

Steps

- 1 Set up 2 top-loading wash dishes, labeled "PB1" and "XC4".
- 2 To indicate the fill volume before filling wash dishes with PB1 and XC4, pour 310 ml water into the wash dishes and mark the water level on the side. Empty the water from the wash dish. Marking the level enables you to pour reagent directly from the PB1 and XC4 bottles into the wash dishes, minimizing contaminant transfer from labware to wash dishes.

Figure 138 PB1 and XC4 Wash Dishes with Staining Rack

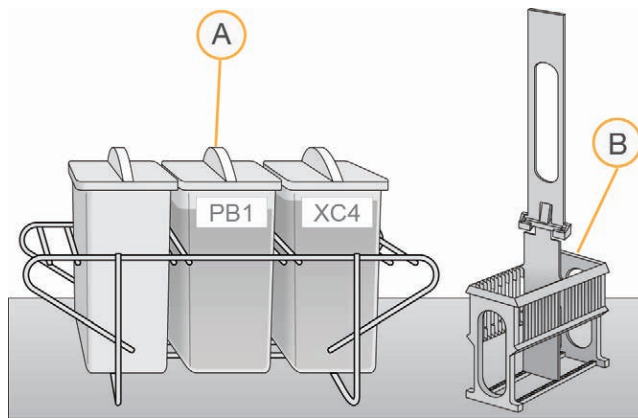

- A Wash Dishes
B Staining Rack

- 3 Pour 310 ml PB1 into the wash dish labeled "PB1."
- 4 Submerge the unloaded staining rack into the wash dish with the locking arms and tab *facing towards* you. This orientation makes it easier and safer to remove the BeadChips. Let the staining rack sit in the wash dish. You will use it to carry the BeadChips after disassembling the flow-through chambers.

Figure 139 Staining Rack Locking Arms and Tab

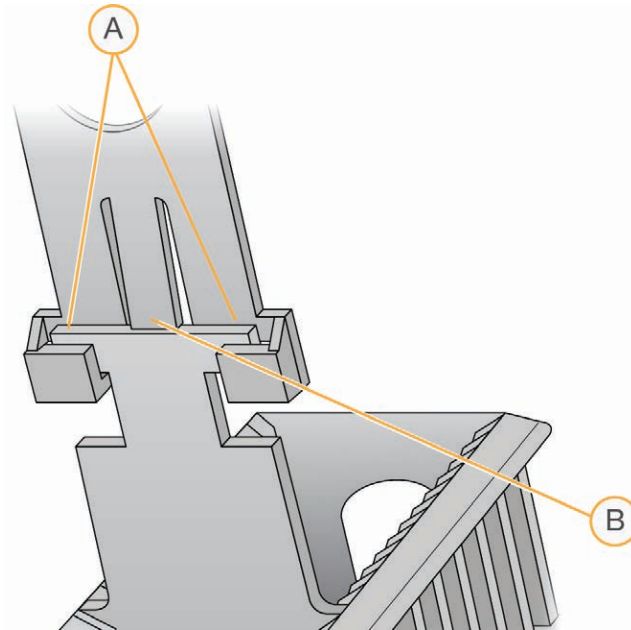

- A Locking Arms
- B Tab



CAUTION

If the staining rack handle is not correctly oriented, the BeadChips can be damaged when you remove the staining rack handle before removing the BeadChips.

- 5 One at a time, disassemble each flow-through chamber:
 - a Use the dismantling tool to remove the 2 metal clamps.



CAUTION

It is important to use the dismantling tool to avoid chipping the glass back plates.

Figure 140 Removing the Metal Clamps from Flow-Through Chamber

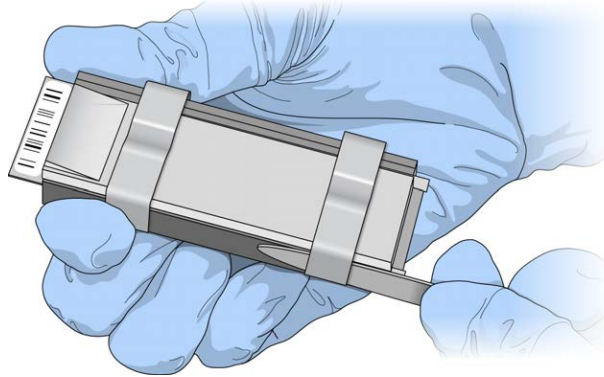

- b Remove the glass back plate.
- c Set the glass back plate aside. When you finish the XStain HD BeadChip protocol, clean the glass back plates as described in the *Infinium Lab Setup and Procedures Guide*.
- d Remove the spacer. To avoid damaging the stripes on the BeadChip, pull the spacer out so that the long sides slide along the sides of the BeadChip.
- e Remove the BeadChip.



CAUTION

Do not touch the face of the BeadChips. Handle them by the barcode end or by the edges.

- 6 Place the BeadChips in the staining rack while it is submerged in PB1. Put 4 BeadChips above the staining rack handle and 4 below the handle. Make sure that the BeadChip barcodes *face away* from you and that the locking arms on the handle *face towards* you.
If necessary, briefly lift the staining rack out of the wash dish to seat the BeadChip. Replace it immediately after inserting each BeadChip.
- 7 Make sure that the BeadChips are submerged.



CAUTION

Do not allow the BeadChips to dry. Submerge each BeadChip in the wash dish as soon as possible.

- 8 Slowly move the staining rack up and down 10 times, breaking the surface of the reagent.



NOTE

If the top edges of the BeadChips begin to touch during either PB1 or XC4 washes, gently move the staining rack back and forth to separate the slides. It is important for the solution to circulate freely between all BeadChips.

Figure 141 Washing BeadChips in PB1

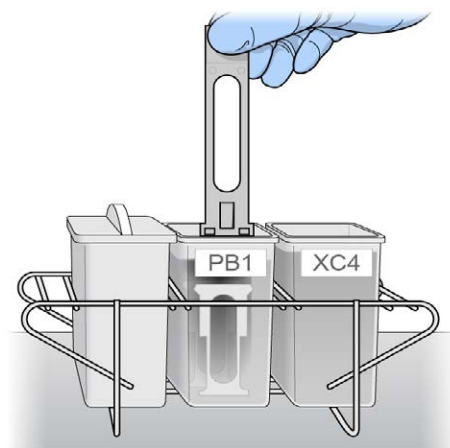

- 9 Allow the BeadChips to soak for an additional 5 minutes.



CAUTION

Do not leave the BeadChips in the PB1 for more than 30 minutes.

- 10 Shake the XC4 bottle vigorously to ensure complete resuspension. If necessary, vortex until dissolved.
- 11 Pour 310 ml XC4 into the dish labeled “XC4,” and cover the dish to prevent any lint or dust from falling into the solution.



CAUTION

Do not let the XC4 sit for longer than 10 minutes.

- 12 Remove the staining rack from the PB1 dish and place it directly into the wash dish containing XC4. For proper handling and coating, The barcode labels on the BeadChips must *face away* from you; the locking arms on the handle must *face towards* you.

Figure 142 Moving BeadChips from PB1 to XC4

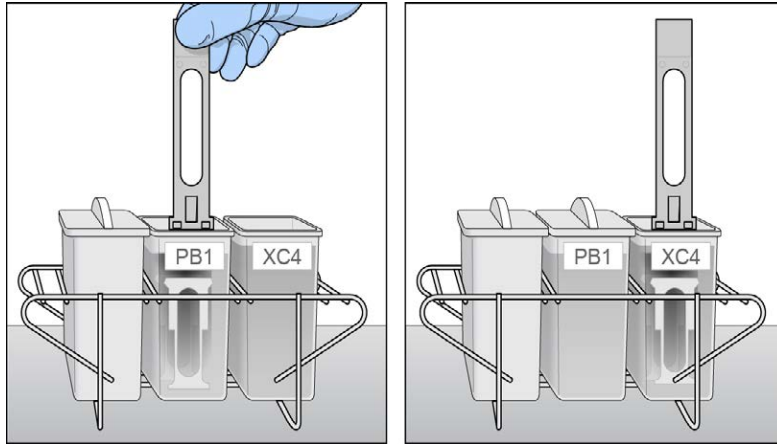

- 13 Slowly move the staining rack up and down 10 times, breaking the surface of the reagent.



NOTE

If the top edges of the BeadChips begin to touch during either PB1 or XC4 washes, gently move the staining rack back and forth to separate the slides. It is important for the solution to circulate freely between all BeadChips.

- 14 Allow the BeadChips to soak for an additional 5 minutes.



CAUTION

Use XC4 only one time. To process subsequent BeadChips, use a new, clean wash dish with fresh XC4.

- 15 Prepare 1 additional tube rack per 8 BeadChips (Illumina-provided from VWR catalog # 60916-748) that fits the internal dimensions of vacuum desiccator.
- 16 Remove the staining rack in one smooth, rapid motion and place it directly on the prepared tube rack, making sure that the barcodes *face up*, and the locking arms and tabs *face down*.

Figure 143 Staining Rack in Correct Orientation

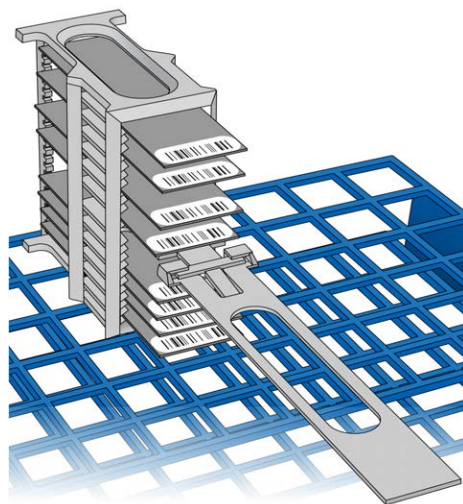

To ensure uniform coating, place the staining rack on the center of the tube rack, avoiding the raised edges.

Figure 144 Moving the Staining Rack from XC4 to Tube Rack

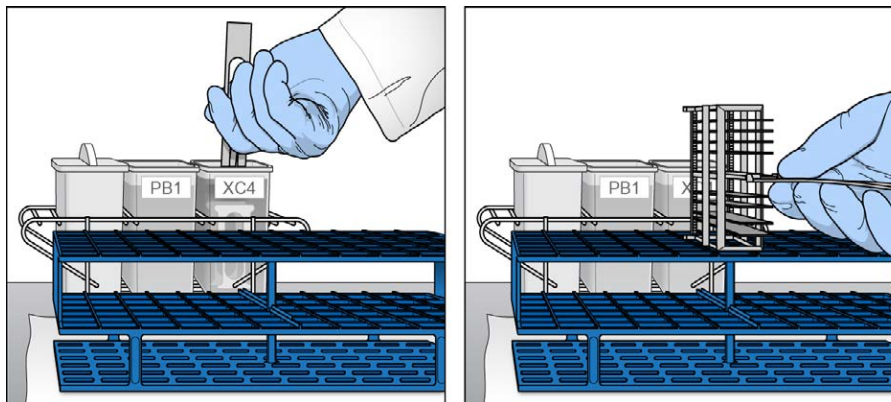

- 17 For each of the top 4 BeadChips, working top to bottom:

- a Continuing to hold the staining rack handle, carefully grip each BeadChip at its barcode end with self-locking tweezers.

**NOTE**

The XC4 coat is slippery and makes the BeadChips difficult to hold. The self-locking tweezers grip the BeadChip firmly and help prevent damage.

- b Place each BeadChip on a tube rack with the barcode *facing up and towards* you.

Figure 145 BeadChips on Tube Rack

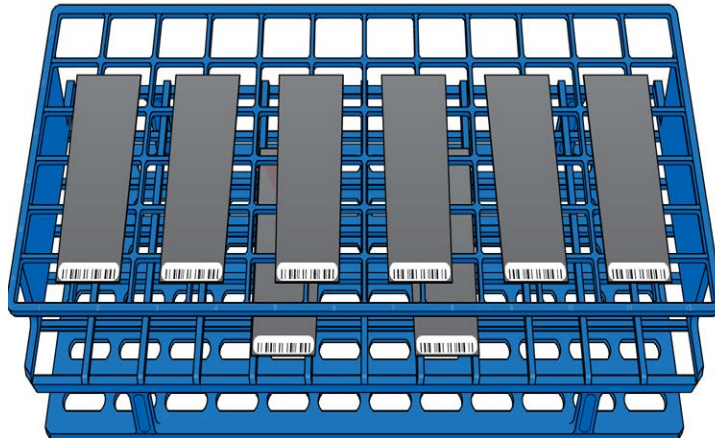

- 18 Holding the top of the staining rack in position, gently remove the staining rack handle by grasping the handle between the thumb and forefinger. Push up the tab with your thumb and push the handle away from you (unlocking the handle), then pull up the handle and remove.

Figure 146 Removing Staining Rack Handle

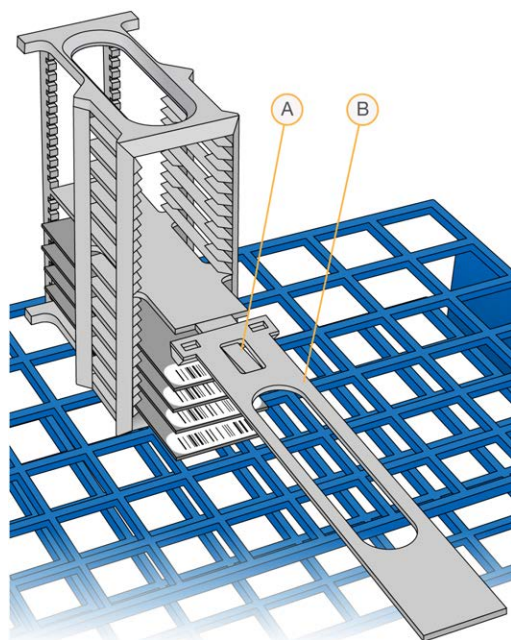

- A Tab
B Handle

- 19 Remove the remaining BeadChips to the tube rack, with 6 BeadChips on top of the rack and 2 BeadChips on the bottom. Make sure that the barcode ends are towards you, and the BeadChips are completely horizontal.



CAUTION

To prevent wicking and uneven drying, do not allow the BeadChips to rest on the edge of the tube rack or to touch each other while drying.

- 20 Place the tube rack in the vacuum desiccator. Each desiccator can hold 1 tube rack (8 BeadChips).



CAUTION

Make sure that the vacuum valve is seated tightly and securely.

- 21 Remove the red plug from the three-way valve before applying vacuum pressure.
22 Start the vacuum, using at least 675 mm Hg (0.9 bar).

- 23 To make sure that the desiccator is properly sealed, gently lift the lid of the vacuum desiccator. It should not lift off the desiccator base.

Figure 147 Testing Vacuum Seal



- 24 Dry under vacuum for 50–55 minutes.
Drying times can vary according to room temperature and humidity.
- 25 Release the vacuum by turning the handle very slowly.



WARNING

Make sure that air enters the desiccator very slowly to avoid disturbing the contents. Improper use of the vacuum desiccator can result in damage to the BeadChips, especially if you remove the valve plug while a vacuum is applied. For detailed vacuum desiccator instructions, see the documentation included with the desiccator.

- 26 Store the desiccator with the red valve plug in the 3-way valve of the desiccator to stop accumulation of dust and lint within the valve port.
- 27 Touch the borders of the BeadChips (**do not touch the stripes**) to make sure that the etched, barcoded sides are dry to the touch.

- 28 If the underside feels tacky, manually clean the underside of the BeadChip to remove any excess XC4. The bottom 2 BeadChips are most likely to have some excess.
 - a Hold the BeadChip at a downward angle to prevent excess EtOH from dripping from the wipe onto the stripes.
 - b Wipe along the underside of the BeadChip 5 or 6 times, until the surface is clean and smooth.

**CAUTION**

Do *not* touch the stripes with the wipe or allow EtOH to drip onto the stripes.

- 29 Clean the glass back plates. For instructions, see the *Infinium Lab Setup and Procedures Guide*.
- 30 Discard unused reagents in accordance with facility standards.
- 31 Do either of the following:
 - Proceed to *Image BeadChip (Post-Amp)*.
 - Store the BeadChips in the Illumina BeadChip Slide Storage Box inside a vacuum desiccator at room temperature. Be sure to image the BeadChips within 72 hours.

Wash and Coat 16–24 BeadChips

Follow either this process for 16–24 BeadChips or the 8 BeadChips Process (see *Wash and Coat 8 BeadChips*).

Before starting the Wash and Coat process, read these important notes:

- ▶ Take the utmost care to minimize the chance of lint or dust entering the wash dishes, which could transfer to the BeadChips. Place wash dish covers on wash dishes when stored or not in use. Clean wash dishes with low-pressure air to remove particulates before use.
- ▶ In preparation for XC4 BeadChip coating, wash the tube racks and wash dishes thoroughly before and after use. Rinse with DI water. Immediately following wash, place racks and wash dishes upside down on a wash rack to dry.
- ▶ Place Kimwipes in 3 layers on the lab bench. Place a tube rack on top of these Kimwipe layers. Do not place on absorbent lab pads. You will place the staining rack containing BeadChips on this tube rack after removing it from the XC4 wash dish.
- ▶ Prepare an additional clean tube rack that fits the internal dimensions of vacuum desiccator for removal of the BeadChips. Allow one rack per 8 BeadChips. No Kimwipes are required under this tube rack.

Equipment Needed

- ▶ 1 staining rack
- ▶ 3 vacuum desiccators (1 per 8 samples)
- ▶ 3 tube racks (1 per 8 samples)
- ▶ Self-locking tweezers
- ▶ Large Kimwipes
- ▶ Vacuum hose

Steps

- 1 Dispense 285 ml PB1 into a wash dish, and then cover the dish.
- 2 Set up 2 top-loading wash dishes, labeled “PB1” and “XC4”.
- 3 To indicate the fill volume before filling wash dishes with PB1 and XC4, pour 285 ml water into the wash dishes and mark the water level on the side. Empty the water from the wash dish. Adding this marker enables you to pour reagent directly from the PB1 and XC4 bottles into the wash dishes, minimizing contaminant transfer from labware to wash dishes.

Figure 148 PB1 and XC4 Wash Dishes with Staining Rack

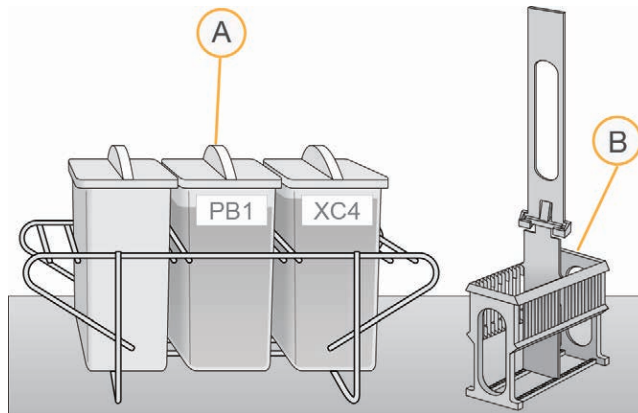

- A Wash Dishes
B Staining Rack

- 4 Pour 285 ml PB1 into the wash dish labeled “PB1.”

- 5 Submerge the unloaded staining rack into the wash dish with the locking arms and tab *facing you*. This orientation enables you to remove the BeadChips safely.

Figure 149 Staining Rack Locking Arms and Tabs

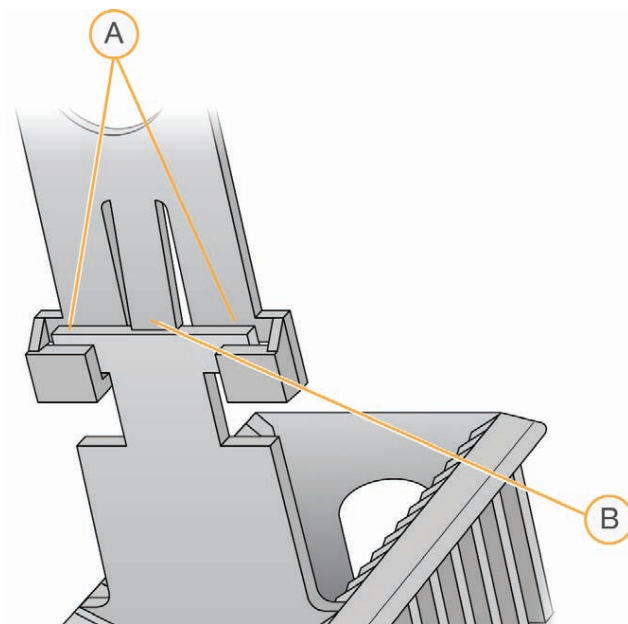

- A Locking Arms
- B Tab



CAUTION

If the staining rack handle is not correctly oriented, the BeadChips might become damaged when you remove the staining rack handle before removing the BeadChips.

- 6 Let the staining rack sit in the wash dish. You will use it to carry the BeadChips after disassembling the flow-through chambers.
- 7 One at a time, disassemble each flow-through chamber:
 - a Using the dismantling tool, remove the 2 metal clamps.



CAUTION

It is important to use the dismantling tool to avoid chipping the glass back plates.

Figure 150 Removing Metal Clamps from Flow-Through Chamber

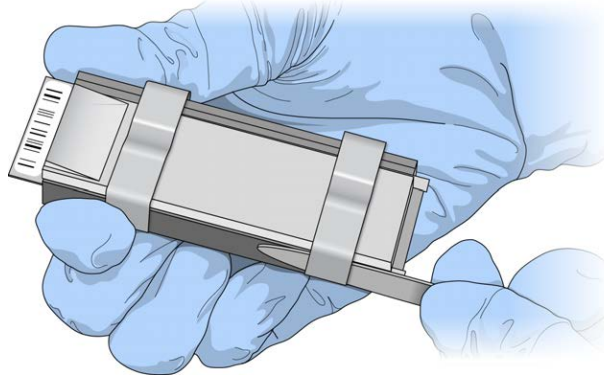

- b Remove the glass back plate.
- c Set the glass back plates aside. When you finish the XStain HD BeadChip protocol, clean the glass back plates as described in the *Infinium Assay Lab Setup and Procedures Guide*.
- d Remove the spacer.
- e Remove the BeadChip.



CAUTION

Do not touch the face of the BeadChips. Handle them by the barcode end or by the edges.

- 8 Place BeadChips in the staining rack while it is submerged in PB1.
 - For 16 BeadChips, place 8 above the handle and 8 below the handle.
 - For 24 BeadChips, place 12 above the handle and 12 below the handle.
 The BeadChip barcodes must *face away* from you, and the locking arms and tab must *face towards* you.

If necessary, briefly lift the staining rack out of the wash dish to seat the BeadChip. Replace it immediately after inserting the BeadChip.

- 9 Make sure that the BeadChips are submerged.



CAUTION

Do not allow the BeadChips to dry. Submerge each BeadChip in the wash dish as soon as possible.

- 10 Move the staining rack up and down 10 times, breaking the surface of the PB1.



NOTE

If the top edges of the BeadChips begin to touch during either PB1 or XC4 washes, gently move the staining rack back and forth to separate the slides. It is important for the solution to circulate freely between all BeadChips.

- 11 Allow the BeadChips to soak for an additional 5 minutes.

Figure 151 Washing BeadChips in PB1

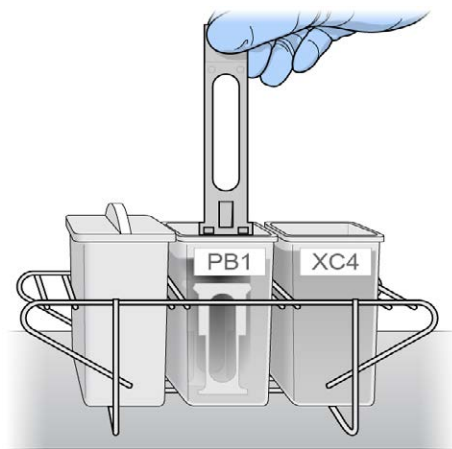

NOTE

Do not leave the BeadChips submerged in PB1 for longer than 30 minutes.

- 12 Pour 285 ml XC4 into the dish labeled “XC4,” and cover the dish to prevent any lint or dust from falling into the solution. Place the bottle with excess XC4 in a readily available location for topping off the ‘XC4’ wash dish during the coating procedure.



NOTE

Use the XC4 within 10 minutes after filling the wash dish.

- 13 Remove the staining rack from the dish containing PB1 and place it directly into the wash dish containing XC4. The barcode labels on the BeadChips must *face away* from you, and the locking arms on the handle must *face towards* you, for proper handling and coating.
- 14 Move the staining rack up and down 10 times, breaking the surface of the XC4.

Figure 152 Moving BeadChips from PB1 to XC4

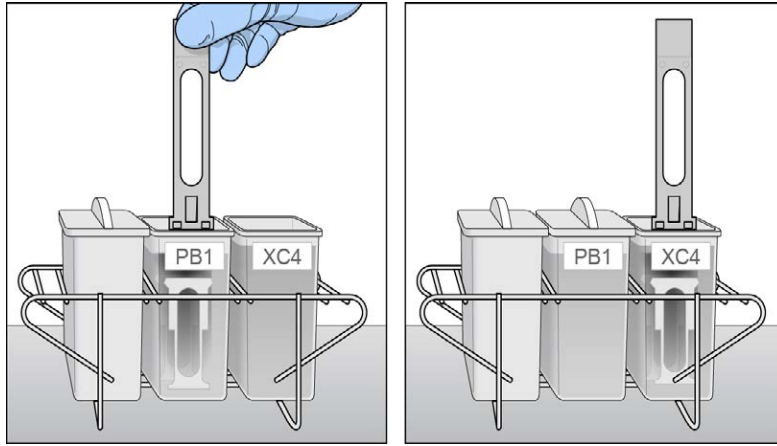

NOTE

If the top edges of the BeadChips begin to touch during either PB1 or XC4 washes, gently move the staining rack back and forth to separate the slides. It is important for the solution to circulate freely between all BeadChips.

- 15 Allow the BeadChips to soak for an additional 5 minutes.



CAUTION

Use XC4 only one time. To process subsequent BeadChips, use a new, clean wash dish with fresh XC4.

- 16 Prepare a clean tube rack for the staining rack by placing 2 folded Kimwipes under the tube rack.
- 17 Prepare 1 additional tube rack per 8 BeadChips (Illumina-provided from VWR catalog # 60916-748) that fits the internal dimensions of the vacuum desiccator.
- 18 Remove the staining rack in one smooth, rapid motion and place it directly on the prepared tube rack. Make sure that the barcodes face up and the locking arms and tab face down.

Figure 153 Staining Rack in Correct Orientation

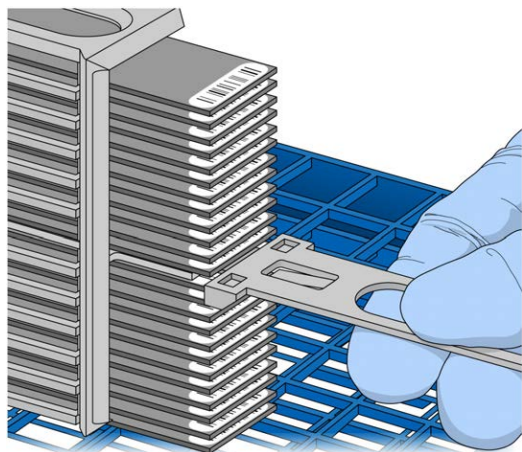

- 19 To ensure uniform coating, place the staining rack on the center of the tube rack, avoiding the raised edges.

Figure 154 Moving the Staining Rack from XC4 to Tube Rack

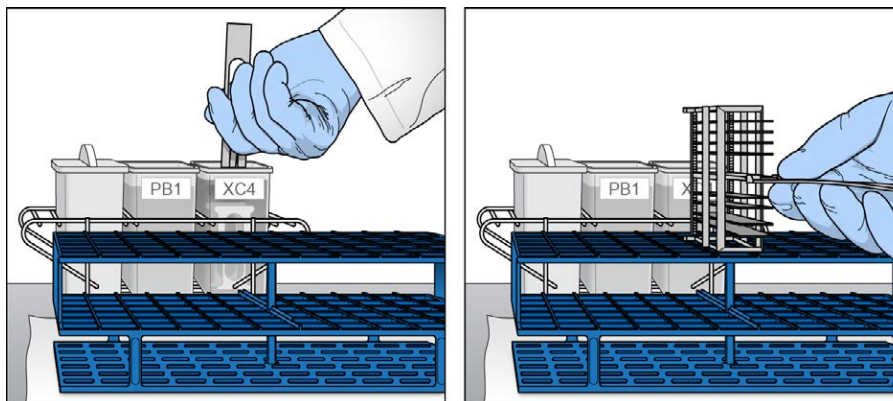

- 20 For the **top 8** BeadChips, working top to bottom:

- a Continuing to hold the staining rack handle, carefully grip each BeadChip at its barcode end with self-locking tweezers. Remove the rack handle if it facilitates removal of the BeadChips.



NOTE

The XC4 coat is slippery and makes the BeadChips difficult to hold. The self-locking tweezers grip the BeadChip firmly and help prevent damage.

- b Put the 8 BeadChips on the tube rack as shown in Figure 155, with 6 BeadChips on top of the rack and 2 BeadChips on the bottom. The barcode ends must face towards you and the BeadChips must be completely horizontal.



CAUTION

To prevent wicking and uneven drying, do not allow the BeadChips to rest on the edge of the tube rack or to touch each other while drying.

Figure 155 BeadChips on Tube Rack

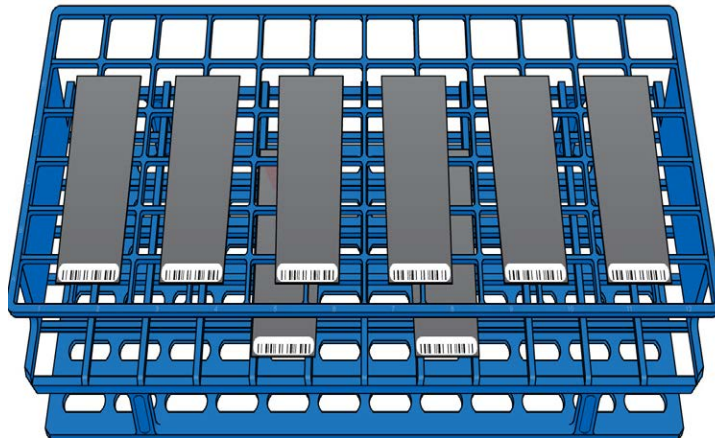

If you are processing 16 BeadChips, 8 remain below the staining rack handle. If you are processing 24 BeadChips, 4 remain above the staining rack handle and 12 remain below the handle.

- 21 Return the staining rack to the XC4 wash dish and top up the wash dish until BeadChips are covered with remaining XC4 reagent.
- 22 Soak the BeadChips for 10 seconds.
- 23 Dry the **first 8** BeadChips:

- a Place the tube rack with the first 8 BeadChips into the desiccator. Check the vacuum pressure and make sure that the valve is securely attached.
 - b Start the vacuum, using at least 675 mm Hg (0.9 bar).
 - c To make sure that the desiccator is properly sealed, gently lift the lid of the vacuum desiccator. It should not lift off the desiccator base.
 - d Dry under vacuum for 50–55 minutes.
Drying times might vary according to room temperature and humidity.
- 24 Remove the staining rack with the remaining BeadChips in 1 rapid motion from the XC4 wash dish and place it directly on the tube rack. Make sure that the BeadChips are horizontal with the barcodes facing up.
- 25 If you are processing 24 BeadChips, remove the 4 BeadChips that remain above the staining rack handle and place them on the tube rack.
- 26 (For both 16- and 24-BeadChip processes) Holding the top of the staining rack in position, grasp the handle between your thumb and forefinger. Push up the tab with your thumb and push the handle away from you to unlock it. Pull up the handle and remove.
- 27 Place BeadChips on the tube rack until there are 6 BeadChips on top of the rack and 2 BeadChips on the bottom. The barcode ends must be towards you and the BeadChips must be completely horizontal.
If you are processing 24 BeadChips, 8 remain in the staining rack.
- 28 If you are processing 24 BeadChips:
- a Return the staining rack with the last 8 BeadChips to the XC4 wash dish and top up the wash dish until BeadChips are covered with remaining XC4 reagent.
 - b Soak the BeadChips for 10 seconds.
- 29 Dry the **second set of 8 BeadChips**:
- a Place the tube rack with the second set of 8 BeadChips into the desiccator. Check the vacuum pressure and make sure that the valve is securely attached.
 - b Start the vacuum, using at least 675 mm Hg (0.9 bar).
 - c To make sure that the desiccator is properly sealed, gently lift the lid of the vacuum desiccator. It should not lift off the desiccator base.
 - d Dry under vacuum for 50–55 minutes.
- 30 If you are processing 24 BeadChips:

- a Remove staining rack with the remaining 8 BeadChips in 1 rapid motion from the 'XC4' wash dish and place it directly on tube rack. Make sure that the BeadChips are horizontal with the barcodes facing up.
- b Place BeadChips on the tube rack as shown in Figure 155 until there are 6 BeadChips on top of the rack and 2 BeadChips on the bottom. The barcode ends must be towards you and the BeadChips must be completely horizontal.
- c Place the tube rack with the **third set of 8 BeadChips** into the desiccator. Check the vacuum pressure and make sure that the valve is securely attached.
- d Start the vacuum, using at least 675 mm Hg (0.9 bar).
- e To make sure that the desiccator is properly sealed, gently lift the lid of the vacuum desiccator. It should not lift off the desiccator base.

Figure 156 Testing Vacuum Seal



- f Dry under vacuum for 50–55 minutes.
- 31 If you are using Illumina LIMS:
 - a In the Illumina LIMS left pane, click **Infinium HD Methylation | Coat BC2**.
 - b Scan the reagent barcodes and BeadChip barcodes. Click **Save**. Illumina LIMS records the data and queues the BeadChips for the next step.
 - 32 Release the vacuum by turning the handle very slowly.

**WARNING**

Air must enter the desiccator very slowly to avoid disturbing the contents. Improper use of the vacuum desiccator can result in damage to the BeadChips, especially if you remove the valve plug while a vacuum is applied. For detailed vacuum desiccator instructions, see the documentation included with the desiccator.

- 33 Store the desiccator with the red valve plug in the desiccator 3-way valve to stop accumulation of dust and lint within the valve port. Remove the red plug from the three-way valve before applying vacuum pressure.
- 34 Touch the borders of the chips (**do not touch the stripes**) to make sure that the etched, barcoded side of the BeadChips are dry to the touch.
- 35 If the underside feels tacky, manually clean the underside of the BeadChip to remove any excess XC4. The bottom 2 BeadChips are the most likely to have some excess.
 - a Hold the BeadChip at a downward angle to prevent excess EtOH from dripping from the wipe onto the stripes.
 - a Wrap a presaturated ProStat EtOH wipe or Kimwipe soaked in EtOH around your index finger.
 - b Wipe along the underside of the BeadChip 5 or 6 times, until the surface is clean and smooth.

**CAUTION**

Do **not** touch the stripes with the wipe or allow EtOH to drip onto the stripes.

- 36 Clean the glass back plates. For instructions, see the *Infinium Assay Lab Setup and Procedures Guide*.
- 37 Clean the Hyb Chambers:
 - a Remove the rubber gaskets from the Hyb Chambers.
 - b Rinse all Hyb Chamber components with DI water.
 - c Thoroughly rinse the 8 humidifying buffer reservoirs.
- 38 Discard unused reagents in accordance with facility standards.
- 39 Do either of the following:
 - Proceed to *Image BeadChip (Post-Amp)*.
 - Store the BeadChips in the Illumina BeadChip Slide Storage Box inside a vacuum desiccator at room temperature. Image the BeadChips within 72 hours.

Image BeadChip (Post-Amp)

Follow the instructions in the *iScan System User Guide* or *HiScan System User Guide* to scan your BeadChips.

Use the **Methylation NXT** scan setting for your BeadChip.



NOTE

Follow the instructions in the *Decode File Client User Guide (11337856)* available on the Illumina support website to download your DMAPs.



NOTE

Use the *GenomeStudio Methylation Module v1.8 User Guide (11319130)* to analyze your data. Use the Infinium >> Infinium HD setting to create a GenomeStudio project for your BeadChip. Analysis requires a sample sheet that describes the location of each sample. See the support web page for your array for a sample sheet template.

Illumina GenomeStudio

Illumina GenomeStudio, an integrated data analysis software platform, provides a common environment for analyzing data obtained from microarray and sequencing technologies. Within this common environment, or framework, the Illumina GenomeStudio software modules allow you to perform application-specific analyses. The Illumina GenomeStudio Methylation Module, included with your Illumina Infinium Methylation Assay system, is an application for extracting genome-wide DNA methylation data from data files collected from systems such as the Illumina HiScan Reader. Experiment performance is based on built-in controls that accompany each experiment.

Data analysis features of the Illumina GenomeStudio Methylation Module include:

- ▶ Choice of assay analysis within a single application
- ▶ Data tables for information management and manipulation
- ▶ Plotting and graphing tools
- ▶ Whole-genome display of sample data in the IGV (Illumina Genome Viewer)
- ▶ Data visualization of one or more samples in the ICB (Illumina Chromosome Browser)
- ▶ Data normalization
- ▶ Custom report file formats
- ▶ Differential methylation analysis
- ▶ Assay-specific controls dashboards

For feature descriptions and instructions on using the Illumina GenomeStudio platform to visualize and analyze genome-wide DNA methylation data, see the *GenomeStudio Framework User Guide* and the *GenomeStudio Methylation Module User Guide*.

For technical assistance, contact Illumina Technical Support.

System Controls

Introduction	220
Control Dashboard	221
Controls Table	222
Control Diagrams	224

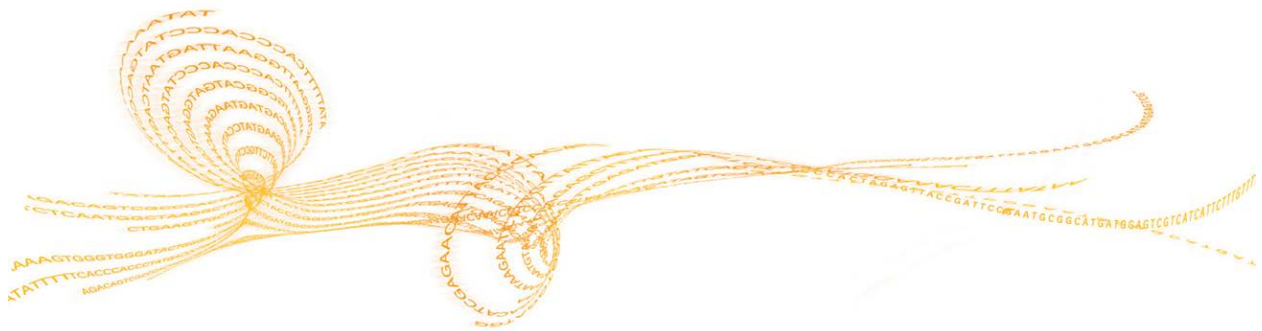

Introduction

This appendix describes the controls used in the Infinium HD Methylation Assay Protocol Guide, including expected outcomes. Diagrams are included with descriptions for sample-independent and sample-dependent controls, as well as controls that are specific to the green channel or red channel. The controls are useful both by themselves and with each other.

Sample-Independent Controls

The sample-independent controls let you evaluate the quality of specific steps in the process flow, and include:

- Staining controls
- Extension controls
- Target removal controls
- Hybridization controls

Sample-Dependent Controls

The sample-dependent controls let you evaluate performance across samples, and include:

- Bisulfite conversion I controls
- Bisulfite conversion II controls
- Specificity I controls
- Specificity II controls
- Nonpolymorphic (NP) controls
- Negative controls

Several key steps in the Infinium HD Assay for Methylation require evaluation of both the red and green color channels. For these instances, both red and green channel controls are included.

Control Dashboard

To view the controls, create an Infinium Methylation analysis workspace using the GenomeStudio Wizard, as described in the *GenomeStudio Framework User Guide* and its *GenomeStudio Methylation Module User Guide*. You can then view the controls performance from the GenomeStudio **Analysis | View Controls Dashboard** menu.

Controls Table

Table 18 Controls

Purpose	Name	Number on the Array	Evaluate Green (GRN)	Evaluate Red (RED)	Expected Intensity
Sample-Independent Controls					
Staining	DNP (High)	1	-	+	High
Staining	DNP (Bgnd)	1	-	+	Background
Staining	Biotin (Med)	1	+	-	High
Staining	Biotin (Bgnd)	1	+	-	Background
Extension	Extension (A), (T)	2	-	+	High
Extension	Extension (C), (G)	2	+	-	High
Hybridization	Hyb (Low)	1	+	-	Low
Hybridization	Hyb (Medium)	1	+	-	Medium
Hybridization	Hyb (High)	1	+	-	High
Target Removal	Target Removal 1, 2	2	+	-	Low
Sample-Dependent Controls					
Bisulfite conversion I	BC conversion I C1, C2, C3	3	+	-	High
Bisulfite conversion I	BC conversion I U1, U2, U3	3	+	-	Background

Purpose	Name	Number on the Array	Evaluate Green (GRN)	Evaluate Red (RED)	Expected Intensity
Bisulfite conversion I	BC conversion I C4, C5, C6	3	-	+	High
Bisulfite conversion I	BC conversion I U4, U5, U6	3	-	+	Background
Bisulfite conversion II	BC conversion II 1, 2, 3, 4	4	-	+	High
Specificity I	GT mismatch 1, 2, 3 (PM)	3	+	-	High
Specificity I	GT mismatch 1, 2, 3 (MM)	3	+	-	Background
Specificity II	Specificity 1, 2, 3	3	-	+	High
Non-Polymorphic	NP (A), (T)	2	-	+	High
Non-Polymorphic	NP (C), (G)	2	+	-	High
Negative	Average*	600	+	+	Background
Negative	StdDev**		+	+	Background

* Average intensity of 600 negative control probes

** Standard deviation of intensities of 600 negative control probes

Control Diagrams

The diagrams in this section illustrate control structure and function.

Sample-Independent Controls

Sample-independent controls evaluate the performance of specific steps in the process flow.

Staining Controls

Staining controls are used to examine the efficiency of the staining step in both the red and green channels. Staining controls have dinitrophenyl (DNP) or biotin attached to the beads. *Controls Table* on page 222 lists the control names, relevant color channel, and expected intensity of biotin and DNP labeling controls. These controls are independent of the hybridization and extension step. Both red and green channels can be evaluated using the Staining Controls.

Figure 157 Staining Controls (Sample-Independent)

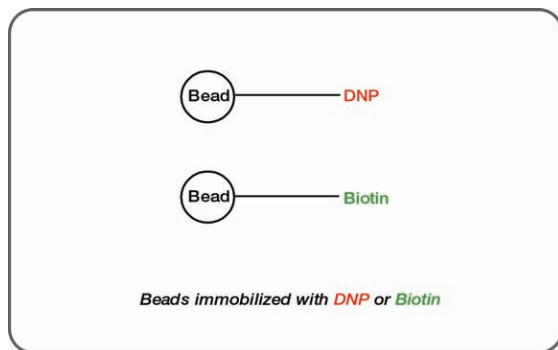

Extension Controls

Extension controls test the extension efficiency of A, T, C, and G nucleotides from a hairpin probe, and are therefore sample-independent. Both red (A,T) and green (C,G) channels are monitored. *Controls Table* on page 222 lists the control names, the relevant color channel, and the expected intensity of the extension controls.

Figure 158 Extension Controls (Sample-Independent)

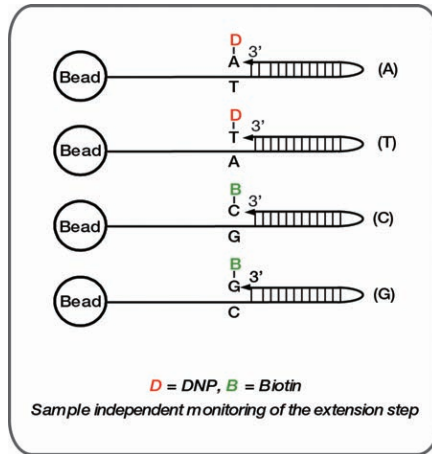

Hybridization Controls

The hybridization controls test the overall performance of the entire assay using synthetic targets instead of amplified DNA. These synthetic targets complement the sequence on the array perfectly, allowing the probe to extend on the synthetic target as template.

The synthetic targets are present in the Hybridization Buffer (RA1) at 3 levels, monitoring the response from high-concentration (5 pM), medium-concentration (1 pM), and low-concentration (0.2 pM) targets. All bead type IDs should result in signal with various intensities, corresponding to the concentrations of the initial synthetic targets. Performance of hybridization controls should only be monitored in the green channel. *Controls Table* on page 222 lists control names for the hybridization controls and expected intensities.

Figure 159 Hybridization Controls (Sample-Independent)

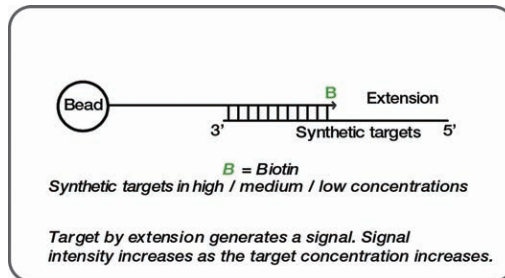

Target Removal Controls

Target removal controls test the efficiency of the stripping step after the extension reaction. In contrast to allele-specific extension, the control oligos are extended using the probe sequence as template. This process generates labeled targets. The probe sequences are designed such that extension from the probe does not occur.

All target removal controls should result in low signal compared to the hybridization controls, indicating that the targets were removed efficiently after extension. The target removal controls are present in the Hybridization Buffer RA1. Performance of target removal controls should only be monitored in the green channel. *Controls Table* on page 222 lists control names and expected signal.

Figure 160 Target Removal Controls (Sample-Independent)

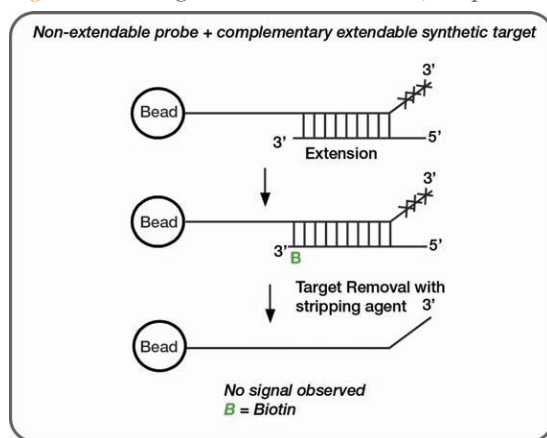

Sample-Dependent Controls

The sample-dependent controls can be used to evaluate performance across samples. These control oligos are designed for bisulfite-converted human genomic DNA sequences. Because target sequences do not contain CpG dinucleotides, the performance of the control oligos does not depend on the methylation status of the template DNA.

Bisulfite-Conversion Controls

These controls assess the efficiency of bisulfite conversion of the genomic DNA. The Infinium Methylation probes query a [C/T] polymorphism created by bisulfite conversion of

non-CpG cytosines in the genome.

Bisulfite-Conversion I

These controls use the Infinium I probe design and allele-specific single base extension to monitor efficiency of bisulfite conversion. If the bisulfite conversion reaction was successful, the "C" (Converted) probes match the converted sequence and are extended. If the sample has unconverted DNA, the "U" (Unconverted) probes are extended. There are no underlying C bases in the primer landing sites, except for the query site itself. Performance of bisulfite conversion controls C1, C2, and C3 should be monitored in the green channel, and controls C4, C5, and C6 should be monitored in red channel.

Figure 161 Bisulfite-conversion I Controls (Sample-Dependent)

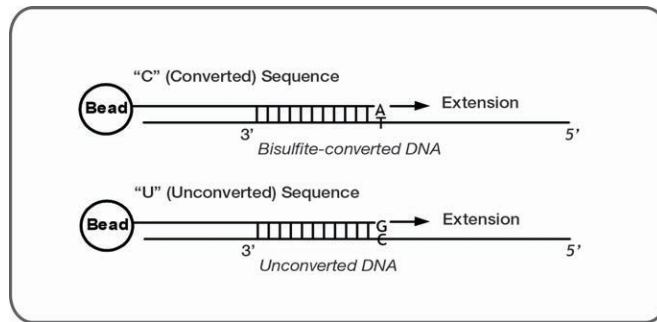

Bisulfite-Conversion II

These controls use Infinium II probe design and single base extension to monitor the efficiency of bisulfite conversion. If the bisulfite conversion reaction was successful, the "A" base is incorporated and the probe has intensity in the red channel. If the sample has unconverted DNA, the "G" base is incorporated across the unconverted cytosine, and the probe has elevated signal in the green channel.

Figure 162 Bisulfite-conversion II Controls (Sample-Dependent)

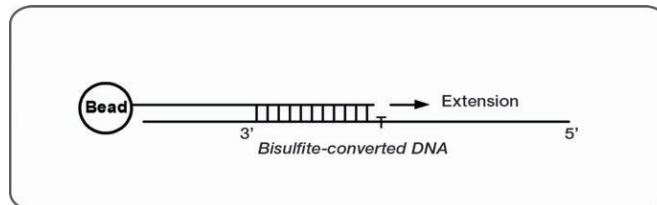

Specificity Controls

Specificity controls are designed to monitor potential nonspecific primer extension for Infinium I and Infinium II assay probes. Specificity controls are designed against nonpolymorphic T sites.

Specificity I

These controls are designed to monitor allele-specific extension for Infinium I probes. The methylation status of a particular cytosine is carried out following bisulfite treatment of DNA by using query probes for unmethylated and methylated state of each CpG locus. In assay oligo design, the A/T match corresponds to the unmethylated status of the interrogated C, and the G/C match corresponds to the methylated status of C. G/T mismatch controls check for nonspecific detection of methylation signal over unmethylated background. PM controls correspond to A/T perfect match and should give high signal. MM controls correspond to G/T mismatch and should give low signal. Performance of GT Mismatch controls should be monitored in both green and red channels. The Controls dashboard table lists expected outcome for controls probes.

Figure 163 Specificity I Controls (Sample-Dependent)

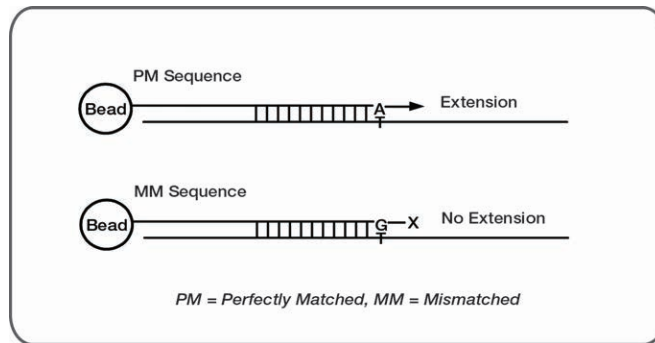

Specificity II

These controls are designed to monitor extension specificity for Infinium II probes and check for potential nonspecific detection of methylation signal over unmethylated background. Specificity II probes should incorporate the "A" base across the nonpolymorphic T and have intensity in the red channel. If there is nonspecific incorporation of the "G" base, the probe has elevated signal in the green channel.

Figure 164 Specificity II Controls (Sample-Dependent)

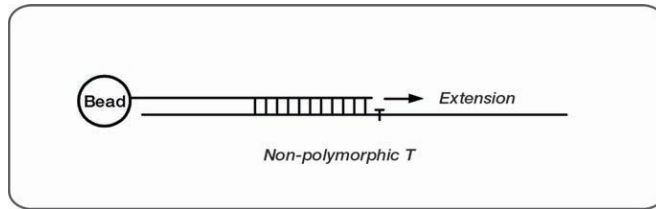

Negative Controls

Negative control probes are randomly permuted sequences that should not hybridize to the DNA template. Negative controls are particularly important for methylation studies because of a decrease in sequence complexity after bisulfite treatment. The mean signal of these probes defines the system background. It is a comprehensive measurement of background, including signal resulting from cross-hybridization and nonspecific extension and imaging system background. The GenomeStudio platform uses the Average signal and standard deviation of 600 negative controls to establish detection limits for the methylation probes. Performance of negative controls should be monitored in both green and red channels.

Nonpolymorphic Controls

Nonpolymorphic controls test the overall performance of the assay, from amplification to detection, by querying a particular base in a nonpolymorphic region of the bisulfite genome. They let you compare assay performance across different samples. One nonpolymorphic control has been designed to query each of the 4 nucleotides (A, T, C, and G). *Controls Table* on page 222 lists the bead type IDs. The target with the C base results from querying the opposite whole genome amplified strand generated from the converted strand.

Figure 165 Non-Polymorphic Controls (Sample-Dependent)

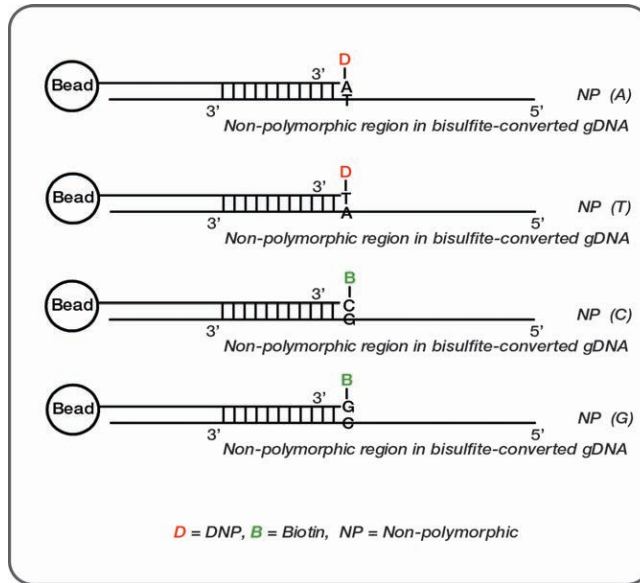

A

arrays 10
AutoLoader2 16

B

BCD plate 33, 122
bead type IDs 222
BeadChip
 alignment fixtures 164
 description 10
 imaging 9
 washing 8
 Xstain, auto protocol 192
biotin controls 224
bisulfite conversion 33, 122

C

color channels
 evaluate 224
 monitor extension 224
control oligos
 See controls 220
controls 230
 bead type IDs 222
 Control Dashboard 221
 extension 224
 hybridization 225
 non-polymorphic 229
 sample-dependent 220, 226, 230
 sample-independent 220, 224-225
 staining controls 224
 target removal 226
customer support 235

D

data analysis 12, 104, 218
differential analysis 104, 218

DNA 26

 amplification bias 5
 amplifying 5
 bisulfite conversion 33, 122
 input amount 35, 124
 fragmenting 5
 incubating 5
 mapping samples to BeadChips 12
 precipitating 6
 preparing for staining, extension 8
 resuspending 6
 tracking samples 12
 washing away 8

DNP 224

documentation 235

E

equipment
 auto protocol 108-109
 manual protocol 22
experienced user cards 12
extension controls 224

F

fluorescence 9
Flow-Through Chambers
 single-base extension 89
 stain 91

G

gDNA input amounts 35, 124
gene analysis 104, 218
GenomeScan 16
GenomeStudio
 Controls Dashboard 221
 integrated informatics 104, 218

H

help, technical 235
 HiScan 16
 HiScan System 193
 hybridization
 controls 225

I

IllumiCode Sequence IDs 222
 Infinium Assay
 overview 2
 Infinium HD Assay
 controls
 See controls 220
 iScan System 16, 193

L

lab setup and procedures 11
 lab tracking form (LTF) 40

M

materials
 auto protocol 110
 automated protocol 22
 manual protocol 24
 methylation
 detection 33, 122
 multiplex 2

N

non-polymorphic controls 229

P

PicoGreen DNA quantitation kit 26
 plates
 BCD 33, 122

Q

quantitate dNA 26

R

reagents
 auto protocol 110
 manual protocol 24

Required Run Items 145, 193
 robot

 BeadChip alignment fixtures 164
 bed map update 145
 dispensing sample 168
 preparing 140, 144, 153, 164, 192
 Required Run Items 145, 193
 resuspend setup 153
 scanning the barcode 168
 Tip Alignment Guide 159, 168
 tube rack 193
 XStain BeadChip setup 192
 Robot Tip Alignment Guide 159, 173

S

sample-dependent controls 226, 230
 non-polymorphic 229
 sample-independent controls 224-225
 extension 224
 hybridization 225
 staining controls 224
 target removal 226
 Sample QDNA plate 26, 113
 sample sheet 12
 SNPs
 number per sample 2
 staining controls 224
 Standard QDNA plate 26, 113
 system controls
 See controls 220

T

target removal controls 226
 Tecan Freedom Evo 15
 Tecan GenePaint 15
 Tecan Genesis 15
 technical assistance 235
 Tip Alignment Guide 159, 168

U

unmethylated cytosines 33, 122

X

XStain BeadChips
 auto protocol 192
 single-base extension 89
 stain 91

Z

Zymo Research

EZ DNA methylation kit 35, 124

Technical Assistance

For technical assistance, contact Illumina Technical Support.

Table 19 Illumina General Contact Information

Website	www.illumina.com
Email	techsupport@illumina.com

Table 20 Illumina Customer Support Telephone Numbers

Region	Contact Number	Region	Contact Number
North America	1.800.809.4566	Italy	800.874909
Australia	1.800.775.688	Netherlands	0800.0223859
Austria	0800.296575	New Zealand	0800.451.650
Belgium	0800.81102	Norway	800.16836
Denmark	80882346	Spain	900.812168
Finland	0800.918363	Sweden	020790181
France	0800.911850	Switzerland	0800.563118
Germany	0800.180.8994	United Kingdom	0800.917.0041
Ireland	1.800.812949	Other countries	+44.1799.534000

Safety Data Sheets

Safety data sheets (SDSs) are available on the Illumina website at support.illumina.com/sds.html.

Product Documentation

Product documentation in PDF is available for download from the Illumina website. Go to support.illumina.com, select a product, then select **Documentation & Literature**.

